

INCIDENT COMMAND SYSTEM

URBAN SEARCH & RESCUE OPERATIONAL SYSTEM DESCRIPTION

ICS-US&R-120-1

November 2014

This document contains information relative to the Incident Command System (ICS) component of the National Interagency Incident Management System (NIIMS). This is

the same Incident Command System developed by FIREScope. Knowledge of the Incident Command System is required to understand the terminology and variety of ways in which the management of resources can be applied.

Additional information and documentation can be obtained from the following sources:

OES - FIREScope - OCC
Document Control
2524 Mulberry Street
Riverside, CA 92501-2200
(909) 782-4174
Fax (909) 782-4239

TABLE OF CONTENTS

Introduction	1
ICS Modular Development	3
Position Descriptions.....	9
Urban Search and Rescue Resource Types	13
Glossary of Terms.....	20
Appendix-A: Five General Construction Categories.....	24
Appendix-B: Four Levels of US&R Operational Capability	29
Appendix-C: Four Levels of US&R Operational Capability Minimum Training	30
Appendix-D: Four Levels of US&R Operational Capability Minimum Equipment Lists and Tool Info Sheets	40
Appendix-E: Regional US&R Task Force.....	58
Appendix-F: State / National US&R Task Force	59
Appendix-G: Structure/Hazards Marking System	61
Appendix-H: Search Marking System	63
Appendix-I: Victim Marking System	66
Appendix-J: Emergency Signaling System	67

INTRODUCTION

The Urban Search and Rescue (US&R) organizational module is designed to provide supervision and control of essential functions at incidents where technical rescue expertise and equipment are required for safe and effective rescue operations. US&R operations are unique in that specialized training and equipment are required to mitigate the incident in the safest and most efficient manner possible.

Initial US&R operations will be directed by the first arriving public safety officer who will assume command as the Incident Commander. Subsequent changes in the incident command structure will be based on the resource and management needs of the incident following established ICS procedures.

Additional resources may include US&R Companies and US&R Crews or modular component of other US&R assets specifically trained and equipped for urban search and rescue operations. The US&R Company is capable of conducting search and rescue operations at incidents where technical expertise and equipment are required. US&R Crews are trained urban search and rescue personnel dispatched to the incident without rescue equipment. US&R Companies and Crews can be assigned as a single resource, grouped to form US&R Strike Teams or added to other resources to form a Task Force. US&R Single Resources, Strike Teams, and Task Forces are managed the same as other incident resources.

Due to the unique hazards and complexity of urban search and rescue incidents, the Incident Commander may need to request a wide variety and amount of multi-disciplinary resources.

US&R Companies and Crews are "typed" based on an identified operational capability. Four levels of US&R operational capability have been identified to assist the Incident Commander in requesting appropriate resources for the incident. These levels are based on five general construction categories and an increasing capability of conducting a rescue at specified emergency situations with an identified minimum amount of training and equipment.

The US&R Type-4 Company (3 personnel minimum) Operational Level represents the minimum capability to conduct safe and effective search and rescue operations at incidents involving non-structural entrapment in non-collapsed structures.

The US&R Type-3 Company (3 personnel minimum) Operational Level represents the minimum capability to conduct safe and effective search and rescue operations at structure collapse incidents involving the collapse or failure of Light Frame Construction and low angle or one-person load rope rescue.

The US&R Type-2 Company (6 personnel minimum) Operational Level represents the minimum capability to conduct safe and effective search and rescue operations at

structure collapse incidents involving the collapse or failure of heavy wall construction, high angle rope rescue (not including highline systems), and trench and excavation rescue.

The US&R Type-1 Company (6 personnel minimum) Operational Level represents the minimum capability to conduct safe and effective search and rescue operations at structure collapse incidents involving the collapse or failure of heavy floor, pre-cast concrete and steel frame construction, high angle rope rescue (including highline systems), permit required confined space rescue, and mass transportation rescue.

The Regional US&R Task Force is comprised of 29 people specially trained and equipped for large and/or complex US&R operations. The multi-disciplinary organization provides five functional elements that include Supervision, Search, Rescue, Medical, and Logistics. The Regional US&R Task Force is totally self-sufficient for the first 24 hours. Transportation and logistical support is provided by the sponsoring agency and may be supported by the requesting agency.

State/National US&R Task Force is comprised of 70 people when configured as a Type I Task Force specially trained and equipped for large or complex US&R operations. The multi-disciplinary organization provides eight functional elements that include Supervision, Search, Rescue, Haz-Mat, WMD, Medical, Logistics and Planning. The State/National US&R Task Force is designed to be used as a "single resource." However, each element of the Task Force is modularized into functional components and can be independently requested and utilized. The State/National US&R Task Force may also be configured as a Type III Task Force with 28 members.

ICS MODULAR DEVELOPMENT

US&R incidents may occur that will require rescue operations that exceed a resource's identified capability. When the magnitude or type of incident is not commensurate with a capability level, the Incident Commander will have the flexibility to conduct rescue operations in a safe and appropriate manner using existing resources within the scope of their training and equipment until adequate resources can be obtained or the incident is terminated.

The flexibility and modular expansion capabilities of the Incident Command System provides a number of ways US&R resources can be arranged and managed. A series of modular development examples are included to illustrate several possible methods of expanding the incident organization based on existing emergency conditions, available resources, and incident objectives.

The ICS Modular Development examples shown are not meant to be restrictive, nor imply these are the only ways to build an ICS organizational structure to manage US&R resources at an incident. To the contrary, the ICS Modular Development examples are provided only to show conceptually how one can arrange and manage resources at an

US&R incident that builds from an initial response to a Multi-Branch organization.

ICS MODULAR DEVELOPMENT EXAMPLES

Initial Response Organization (Example Page 5): The first arriving Public Safety Officer will assume command of the incident as the Incident Commander (IC). The IC will assume all Command and General Staff functions and responsibilities and manage initial response resources. If the potential for escalation is low, then no specific ICS functional positions are established. If the incident requires an upgraded response, then the IC should consider the early establishment of ICS positions. The following examples illustrate this modular growth of the ICS structure to keep pace with increased resource response.

Reinforced Response Organization (Example Page 6): In addition to the initial response, more Law Enforcement, local Engine and Truck Companies and Mutual Aid resources have arrived. The IC forms a Unified Command with the senior ranking Law Enforcement official on scene and has established a Safety Officer to assure personnel safety. A Public Information Officer has been assigned to manage the large media presence. An Operations Section has been assigned to manage the tactical assignments and responsibilities. A Staging Area is established to check-in arriving resources. A US&R Group has been established to better coordinate the search and rescue efforts. Public Works is removing debris from the street to improve access and egress routes.

Multi-Group/Division Response Organization (Example Page 7): The IC has added a Liaison Officer to the Command Staff to coordinate assisting agencies participation and assigned a Planning and Logistics Section. One US&R Technical Specialist who understands the unique complexities and resource requirements at US&R incidents is assigned to the Planning Section. The Operations Section has established several Groups and Divisions to better coordinate the large volume of diverse resources at the incident. A Law Group and Medical Group have been formed. One State/National US&R Task Force has arrived and is assigned to Division "A". One Structural Engineer Technical Specialist from the Planning Section is assigned to Division "B" to conduct structural damage assessment. A Hand Crew Strike Team is assisting with debris removal.

Multi-Branch Response Organization (Example Page 8): The Incident Commander has assigned a Finance/Admin Section. The Operations Section has established five branches with similar functions to better coordinate and manage resources. The Planning, Logistics and Finance/Admin Section have several Units operational to support the large amount of resources at the incident.

**INITIAL
RESPONSE***

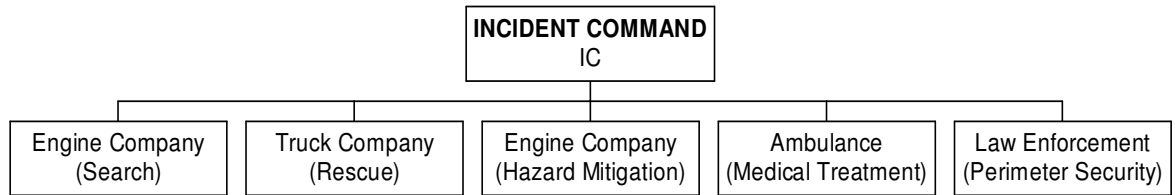

* INITIAL RESPONSE ORGANIZATION (EXAMPLE)

Initial Response Organization (Example Page 5)

The first arriving Public Safety Officer will assume command of the incident as the Incident Commander (IC). The IC will assume all Command and General Staff functions and responsibilities and manage initial response resources. If the potential for escalation is low, then no specific ICS functional positions are established. If the incident requires an upgraded response, then the IC should consider the early establishment of ICS positions. The following examples illustrate this modular growth of the ICS structure to keep pace with increased resource response.

**REINFORCED
RESPONSE***

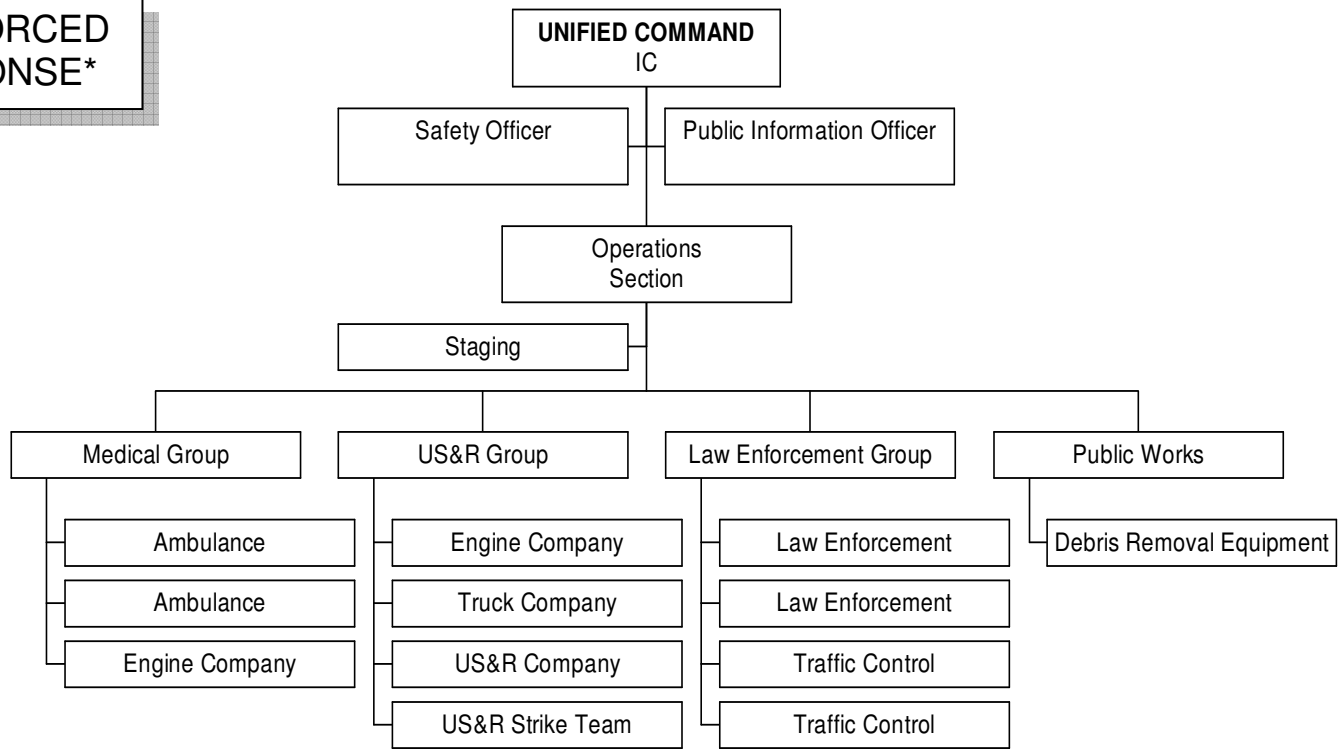

* REINFORCED RESPONSE ORGANIZATION (EXAMPLE)

In addition to the initial response, more Law Enforcement, local Engine and Truck Companies and Mutual Aid resources have arrived. The IC forms a Unified Command with the senior ranking Law Enforcement official on scene and has established a Safety Officer to assure personnel safety. A Public Information Officer has been assigned to manage the large media presence. An Operations Section has been assigned to manage the tactical assignments and responsibilities. A Staging Area is established to check-in arriving resources. A US&R Group has been established to better coordinate the search and rescue efforts. Public Works is removing debris from the street to improve access and egress routes.

MULTI GROUP RESPONSE*

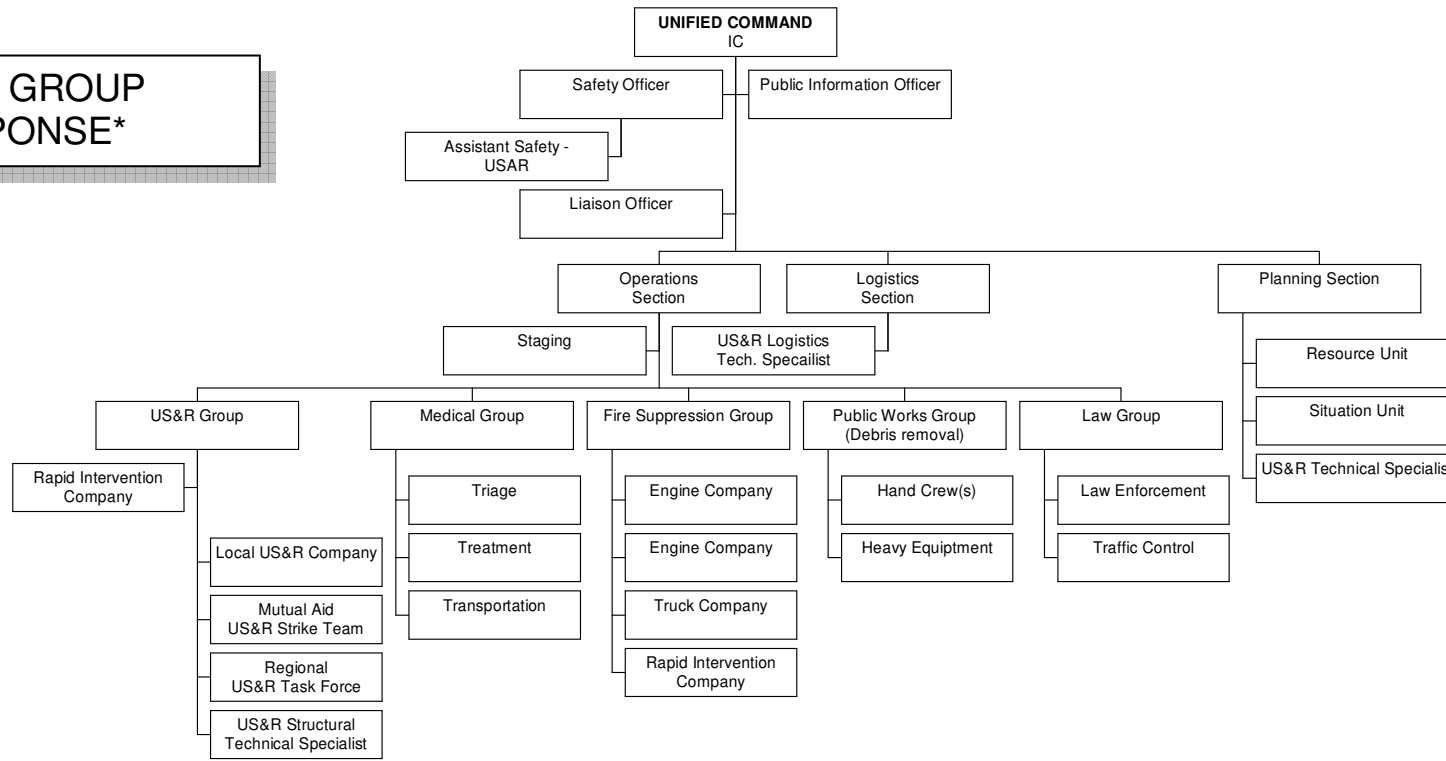

*** MULTI-GROUP RESPONSE ORGANIZATION (EXAMPLE)**

The IC has added a Liaison Officer to the Command Staff to coordinate assisting agencies participation and assigned a Planning and Logistics Section. One US&R Technical Specialist who understands the unique complexities and resource requirements at US&R incidents is assigned to the Planning Section. The Operations Section has established several Groups and Divisions to better coordinate the large volume of diverse resources at the incident. A Law Group and Medical Group have been formed. A Regional US&R Task Force has been assigned to the US&R Group. One State/National US&R Task Force has arrived and is assigned to Division "A". One Structural Engineer Technical Specialist from the Planning Section is assigned to Division "B" to conduct structural damage assessment. A Hand Crew Strike Team is assisting with debris removal.

MULTI-BRANCH RESPONSE*

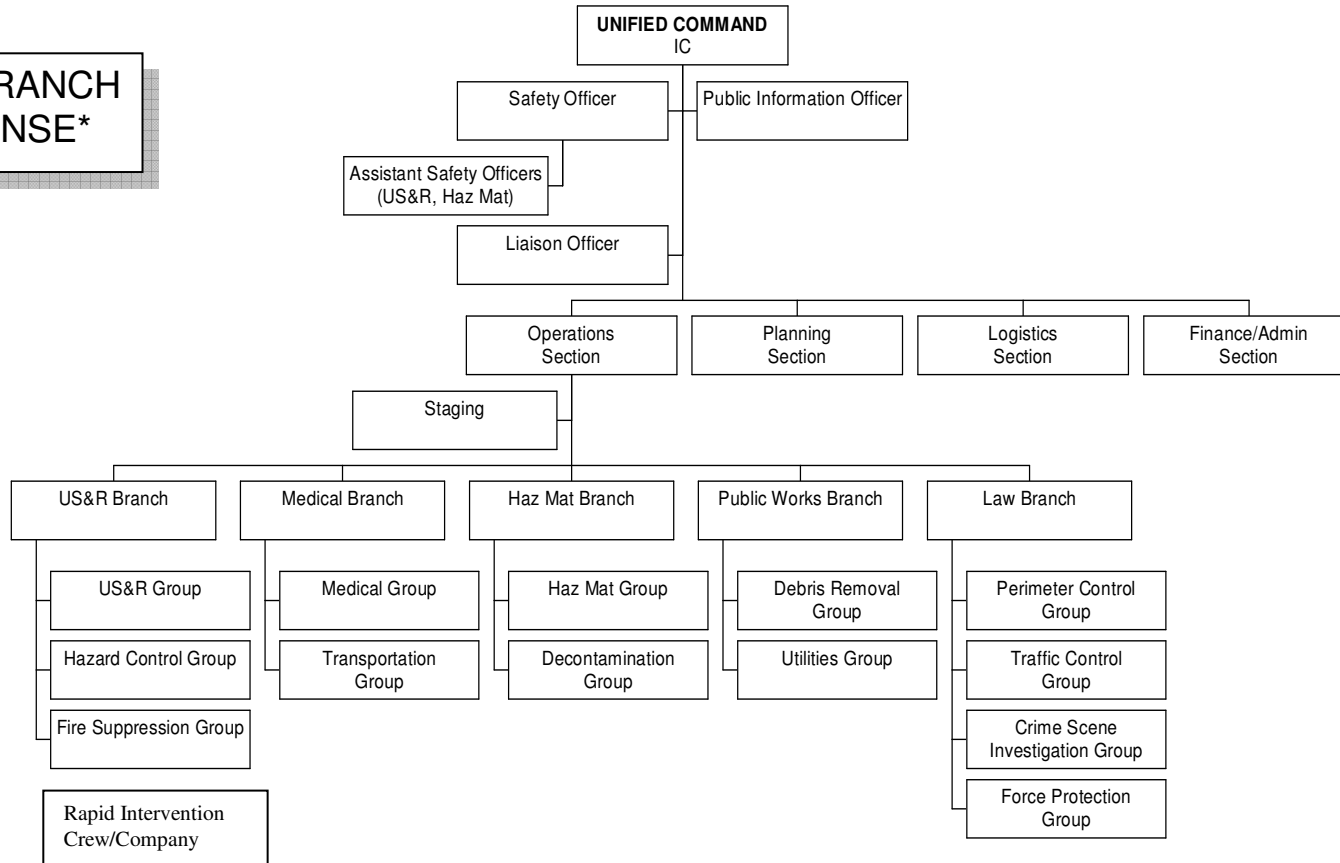

*** MULTI-BRANCH RESPONSE ORGANIZATION (EXAMPLE)**

The Incident Commander has assigned a Finance/Admin Section. The Operations Section has established five branches with similar functions to better coordinate and manage resources. The Planning, Logistics and Finance/Admin Section have several Units operational to support the large amount of resources at the incident.

Position Checklist

*Disclaimer – Some US&R position titles are inconsistent with the ICS/NIMS framework. The independent development of the Federal US&R functions prior to the NIMS adoption of ICS created such inconsistencies.

US&R BRANCH DIRECTOR – US&R OPBDs are under the direction of the Operations Section Chief. US&R OPBDs may have a variety of organized resources under their command to include US&R, Hazard Control, Fire Suppression, and Rapid Intervention Groups/Divisions. US&R OPBDs are responsible for the implementation of the portion of the Incident Action Plan appropriate to the geographical and functional US&R Branches.

- a. Review Common Responsibilities (Page 1-2)
- b. Develop with subordinates alternatives for US&R Branch control operations.
- c. Attend planning meetings at the request of the Operations Section Chief.
- d. Review Division/Group Assignment Lists (ICS Form 204) for Divisions/Groups within the US&R Branch. Modify lists based on effectiveness of current operations.
- e. Assign specific work tasks to Division and Group Supervisors.
- f. Supervise Branch operations.
- g. Resolve logistical problems reported by subordinates.
- h. Report to Operations Section Chief when the Incident Action Plan is to be modified, additional resources are needed, surplus resources are available, or when hazardous situations or significant events occur.
- i. Approve accident and medical reports (home agency forms) originating within the US&R Branch.
- j. Maintain Unit/Activity Log (ICS Form 214).

US&R DIVISION OR GROUP SUPERVISOR - US&R Division and Group Supervisors report to the Operations Section Chief (or Branch Director when activated). The US&R Division/Group Supervisor is responsible for the implementation of the assigned portion of the Incident Action Plan addressing US&R operations. The US&R Division/Group Supervisor may have a variety of organized resources under their command to include Engine Companies, Truck Companies, US&R Crews, US&R Companies, US&R Strike Teams, US&R Regional Task Forces, and State/National Task Forces. They are responsible for the assignment of US&R resources within the US&R Division or Group, reporting on the progress of control operations, and the status of US&R resources within the Division or Group. Division Supervisors are assigned to a specific geographical area of an incident. Group Supervisors are assigned to accomplish specific functions within the incident (i.e. Recon, Search, Rescue, Medical Specialists, Rapid Intervention, etc.). The US&R Division/Group Supervisor is responsible for performing the following functions at an incident:

- a. Review common responsibilities (Page 1-2)
- b. Implement Incident Action Plan for the US&R Division or Group.
- c. Provide Incident Action Plan to Task Force/Strike Team Leaders when available.
- d. Identify resources assigned to the US&R Division or Group.
- e. Review assignments and incident activities with subordinates and assign tasks.

- f. Establish personnel accountability for resources within the US&R Division or Group.
- g. Brief subordinates on appropriate provisions of the incident Site Safety and Control Plan (ICS Form 208) and deployment / activation plans for the Rapid Intervention Crew/Company.
- h. Ensure that Incident Communications and/or Resources Unit are advised of all changes in status of resources assigned to the US&R Division or Group.
- i. Coordinate activities with adjacent Divisions or Groups.
- j. Determine need for assistance on assigned tasks.
- k. Submit situation and resource status information to Operations Branch Director or Operations Section Chief.
- l. Report hazardous situations, special occurrences, or significant events (e.g. accidents, sickness) to immediate supervisor.
- m. Ensure that assigned personnel and equipment get to and from assignments in a timely manner.
- n. Resolve logistics problems within the US&R Division or Group.
- o. Participate in the development of tactical plans for the next operational period.
- p. Maintain Unit/Activity Log (ICS Form 214)

ASSISTANT SAFETY OFFICER – US&R- Reports to the Incident Safety Officer as an Assistant Safety Officer and coordinates with the appropriate supervisor. The Assistant Safety Officer-US&R must possess the appropriate training to coordinate safety related activities for US&R operations. This position advises the appropriate supervisor on all aspects of health and safety and has the authority to stop or prevent unsafe acts.

- a. Review Common Responsibilities (Page 1-2).
- b. Obtain briefing from the appropriate supervisor.
 - c. Participate in the preparation of and implement the incident Site Safety and Control Plan (ICS Form 208 and Form 215A) to include appropriate mitigation measures, such as Personnel accountability and Rapid Intervention Crew / Company.
 - d. Advise their immediate supervisor of deviations from the incident Site Safety and Control Plan (ICS Form 208) or any dangerous situations.
 - e. Has authority to alter, suspend, or terminate any activity that may be judged to be unsafe.
 - f. Work with US&R Task Force Team Managers to establish acceptable entry conditions and appropriate personal protective equipment to be worn by personnel entering the hazard zone.
 - g. Ensure the protection of personnel from physical, environmental, and chemical hazards/exposures.
 - h. Conduct incident/accident investigations with appropriate Task Force personnel under the direction of the Incident Safety Officer and Task Force Leader.
 - i. Ensure the provision of required emergency medical services for assigned personnel and coordinate with medical personnel.
 - j. Maintain unit records, including Unit/Activity Log (ICS Form 214).

RESCUE MANAGER – Reports directly to the US&R Task Force Leader. Is responsible for managing US&R Rescue Operations and supervising assigned resources:

- a. Review Common Responsibilities (Page 1-2).
- b. Coordinate, manage, and supervise assigned rescue activities.
- c. Assist in the development and implementation of the Task Force Tactical Action Plan.
- d. Provide a mission specific Rapid Intervention Plan including personnel & equipment needs.
- e. Adhere to all safety procedures including accountability of personnel.
- f. Determine rescue logistical needs.
- g. Receive briefings and situation reports and ensuring that all rescue personnel are kept informed of mission objectives and status changes.
- h. Provide situation updates and maintain records and reports.
- i. Provide accountability, maintenance, and minor repairs for all issued equipment.
- j. Maintain unit records, including Unit/Activity Log (ICS Form 214).

SEARCH MANAGER – Reports directly to the US&R Task Force Leader. The Search Manager is responsible for managing US&R Search Operations and supervising assigned resources:

- a. Review Common Responsibilities (Page 1-2).
- b. Develop and implement the search component of the US&R Task Force Tactical Action Plan
- c. Adhere to all safety procedures including accountability of personnel.
- d. Coordinate and supervise all assigned search and Recon activities.
- e. Determine search and reconnaissance operational, organizational and logistical needs.
- f. Land navigation and site mapping (GPS).
- g. Receive briefing and situation reports and ensure that all search personnel are kept informed of status changes.
- h. Maintain unit records, including Unit/Activity Log (ICS Form 214).

US&R TECHNICAL SEARCH SPECIALIST – Reports directly to the Search Manager. The US&R Technical Search Specialist is responsible for performing the technical search function of the US&R Task Force incident operations:

- a. Review Common Responsibilities (Page 1-2).
- b. Search areas as assigned using appropriate electronic search equipment and techniques.
- c. Document locations of possible finds and if possible, estimate the status of the victim(s).
- d. Cooperate with and assist other US&R Resources.
- e. Land navigation and site mapping (GPS)
- f. Provide accountability for all issued equipment.
- g. Perform additional tasks or duties as assigned during an incident.
- h. Maintain unit records, including Unit/Activity Log (ICS Form 214).

US&R MEDICAL SPECIALIST - Reports directly to their immediate supervisor as determined by the incident organization. The Medical Specialist is responsible for providing advanced life support medical care to responders, victims, and US&R canines in environments that require special US&R training:

- a. Review Common Responsibilities (Page 1-2).
- b. Provide emergency medical care to Task Force personnel, incident victims, and US&R canines in environments requiring specialized US&R training.
- c. Develop and implement a Medical Action Plan as specified by the US&R Task Force Leader.
- d. Adhere to all safety procedures.
- e. Provide accountability, maintenance and minor repairs of assigned medical equipment.
- f. Perform additional tasks or duties as assigned during an incident.
- g. Maintain unit records, including Unit/Activity Log (ICS Form 214).

US&R STRUCTURES SPECIALIST - Reports directly to their immediate supervisor as determined by the incident organization. The Structures Specialist - US&R is responsible for performing the various structure assessments during incident operations:

- a. Review Common Responsibilities (Page 1-2).
- b. Assess the structural condition within the area of US&R operations. This includes identification of structure types, specific damage and structural hazards.
- c. Recommend the appropriate type and amount of structural hazard mitigation required to minimize the risks to task force personnel.
- d. Adhere to all safety procedures.
- e. Cooperate with and assist other US&R Resources.
- f. Provide accountability, maintenance, and minor repairs for all issued equipment.
- g. Perform additional tasks of duties as assigned during an incident.
- h. Monitor assigned structures for changes in condition during incident operations.
- i. Actively participate in implementation of approved structure hazard mitigation as a designer and/or supervisor.
- j. Coordinate and communicate structure hazard mitigation measures with the Search Manager.
- k. Maintain unit records, including Unit/Activity Log (ICS Form 214).

US&R CANINE SEARCH SPECIALIST – Reports directly to the Search Manager. The US&R Canine Search Specialist is responsible for performing the canine search function of the incident. Responsibilities include searching collapsed structures, water, debris piles, land and mudslides, or fire areas as assigned, using appropriate search techniques and dog handler skills. The US&R Canine Search Specialist is responsible for documenting locations of alerts and estimating the status of victims and cooperating with and assisting other search and rescue resources:

- a. Review Common Responsibilities (Page 1-2).
- b. Obtain briefing from appropriate supervisor.
- c. Accountable for all issued equipment.
- d. Care and welfare of their canine, including assisting medical personnel with the canine's care.
- e. Performs additional tasks or duties as assigned during the incident.
- f. Maintain unit records, including Unit/Activity Log (ICS Form 214).

Page Intentionally Left Blank

URBAN SEARCH & RESCUE RESOURCE TYPES

Always use the prefix US&R for Urban Search and Rescue (US&R) resources.
 Order Single Resource or Strike Team by Type (Capability – Type 1, Type 2, Type 3, OR Type 4)

	Type 1 (Heavy)	Type 2 (Medium)	Type 3 (Light)	Type 4 (Basic)
Type	<ul style="list-style-type: none"> • Heavy Floor Construction • Pre-cast Concrete Construction • Steel Frame Construction • High Angle Rope Rescue (including highline systems) • Confined Space Rescue (permit required) • Mass Transportation Rescue 	<ul style="list-style-type: none"> • Heavy Wall Construction • High Angle Rope Rescue (not including highline systems) • Confined Space Rescue (no permit required) • Trench and Excavation Rescue 	<ul style="list-style-type: none"> • Light Frame Construction • Low Angle Rope Rescue • Single Person Load Rope Rescue 	<ul style="list-style-type: none"> • Surface Rescue • Non-Structural Entrapment in Non-Collapsed Structures

RESOURCE	RADIO	COMPONENT	TYPES			
			1	2	3	4
US&R Company	Agency Identifier US&R (phonetic) Number Identifier (VNC US&R 54)	Equipment Personnel Transportation	Type 1 Inventory 6 *	Type 2 Inventory 6 *	Type 3 Inventory 3 *	Type 4 Inventory 3 *
US&R Crew **	Agency Identifier Type Identifier Number Identifier (KRN-US&R Crew 2)	Personnel Trained To Appropriate Level Supervision Transportation	6	6	3	3
Regional US&R Task Force	Region Identifier Task Force Number Identifier (LOB US&R RTF-3)	Equipment Personnel Transportation	A Regional US&R Task Force is comprised of 29 persons specially trained and equipped for extended US&R Operations. Regional US&R Task Forces are self sufficient for 24 hours.			

State/National US&R Task Force	State ID Task Force Number Identifier (LAC US&R TF-2)	Equipment Personnel Transportation	A State/National US&R Task Force (Type 1, or 3) is comprised of personnel specially trained and equipped for large or complex US&R Operations. State/National US&R Task Forces are self sufficient for 24-72 hours.
--------------------------------	---	--	---

*Requests should include vehicle capabilities when necessary (i.e., four wheel drive, off-road truck, etc.)

**The agency/department sending the US&R Crew will identify the Supervisor.

US&R STRIKE TEAM TYPES AND MINIMUM STANDARDS

	Strike Team Types	Number/Type	Minimum Task Capabilities	Strike Team Leader	Per Single Resource	Total Personnel
Kind U S & R C O M P A N Y	AR	2 – Type 1 (Heavy)	Vehicle (s) Equipped for Heavy Floor Construction, Pre-cast Concrete Construction, Steel Frame Construction, High Angle Rope Rescue (including highline systems), Confined Space Rescue (permit required), and Mass Transportation Rescue	1	6	13
	BR	2 – Type 2 (Medium)	Vehicle (s) Equipped for Heavy Wall Construction, High Angle Rope Rescue (not including highline systems), and Trench and Excavation Rescue	1	6	13
	CR	5 – Type 3 (Light)	Vehicle (s) Equipped for Light Frame Construction and Low Angle Rope Rescue	1	3	16
	DR	5 – Type 4 (Basic)	Vehicle (s) Equipped for Surface Rescue and Non-Structural Entrapment in Non-Collapsed Structures	1	3	16

	Strike Team Types	Number/Type	Minimum Task Capabilities	Strike Team Leader	Per Single Resource	Total Personnel
Kind U S & R C R E W	GR	2 – Type 1 (Heavy)	Trained for Heavy Floor Construction, Pre-cast Concrete Construction, Steel Frame Construction, High Angle Rope Rescue (including highline systems), Confined Space Rescue (permit required), and Mass Transportation Rescue	1	6	13
	HR	2 – Type 2 (Medium)	Trained for Heavy Wall Construction, High Angle Rope Rescue (not including highline systems), and Trench and Excavation Rescue	1	6	13
	IR	5 – Type 3 (Light)	Trained for Light Frame Construction and Low Angle Rope Rescue	1	3	16
	JR	5 – Type 4 (Basic)	Trained for Surface Rescue and Non-Structural Entrapment in Non-Collapsed Structures	1	3	16

R = Urban Search and Rescue Resource

US&R SEARCH TEAM

Resource	Radio Designation	Components	Capabilities	Total Personnel
Search Team	Search Team	1 – Search Manager 1 – Technical Search Specialist 2 – Canine Search Specialist	Detection of victims entombed in collapsed or failed structures and environmental mishap with canines and Technical Search equipment.	4

US&R CANINE SEARCH TEAM

Resource	Radio Designation	Components	Capabilities	Total Personnel
Canine Search Team	Canine Search Team	1 – Search Manager 2 – Canine Search Specialist	Detection of victims entombed in collapsed or failed structures and environmental mishap with canines	3

Cal EMA - FIRE & RESCUE US&R CANINE SEARCH SPECIALIST

<p>Canine is able to conduct large and complex search quickly to locate live victims that are entrapped or injured in an US&R incident. A second canine should be used whenever possible to confirm victim locations.</p>	
Resource	Usage and Capabilities
US&R Canine (Type 1)	<ul style="list-style-type: none"> • Detection in largest search areas • Work in major damage and confined spaces • Detection ability amidst numerous distractions • Detection of victims entombed in collapsed or failed structures and environmental mishap
US&R Canine (Type 2)	<ul style="list-style-type: none"> • Detection in limited search areas • All general construction categories • Extensive obstacle agility

Cal EMA - LAW ENFORCEMENT US&R CANINE SEARCH HANDLER*

Resource best used in area searches with minor damage and rubble.	
Resource	Usage and Capabilities
US&R Canine (Type 3)	<ul style="list-style-type: none"> • Area Search • Non-structural entrapment in non-collapsed structures • US&R Awareness
US&R Canine (Type 4)	<ul style="list-style-type: none"> • Area Search with light to minor structural entrapment Exposure • US&R Awareness

*Canine US&R Search Handler is the law enforcement equivalent to the Fire & Rescue term US&R Canine Search Specialist.

Cal EMA LAW ENFORCEMENT CANINE RECOVERY TEAMS

Search element qualifications and equipment are equivalent on all Canine Types. The differentiating factor is based on the training and certification levels of the canine component. Canine Search Teams will have met all of the capabilities of the preceding types.			
Resource	Type 1 Cadaver Basic	Type 2 Live or Deceased	Type 3 Water
Law Enforcement Canine	<ul style="list-style-type: none"> • Body above ground • Sub-surface disarticulated • Hanging • Simple structure 	<ul style="list-style-type: none"> • Body above ground • Hanging • Live person, must be area certified • Status of subject unknown 	<ul style="list-style-type: none"> • Submerged • Floating • Shoreline

US&R SEARCH TYPES

Reconnaissance Search – Recon is the preliminary survey for the purpose of determining the scope and magnitude of the incident and identifying the resources needed to manage the incident. Other considerations for Recon include;

- Initial visual check of damaged area and/or assigned area of operation
- May be conducted on foot, by vehicle, by watercraft, or by air
- For isolated structure collapse incidents the primary purpose of this action is structural assessment and hazardous materials assessment
- Known locations of live or deceased victims will be recorded and appropriate rescue or recovery resources will be requested
- Size and make up of recon teams are incident driven and flexible
- Recon teams should not engage in rescue operations
- Timely reporting of recon information is critical to the health and safety of responders, survivability of victims, and effective management of the incident

Rapid Search (Hasty Search) - is a fast paced and methodical search in an attempt to locate victims that are in immediate need of rescue. Other considerations for Rapid Search include;

- May be conducted on foot, by vehicle, by watercraft, or by air
- Size and make up of Hasty Search teams are incident driven and flexible
- If live victims are located and can be easily evacuated they will be immediately removed and moved to the identified casualty collection point
- Known locations of live or deceased victims will be recorded and appropriate rescue or recovery resources will be requested
- Documentation of areas searched must be recorded and reported
- Rapid Search may be accomplished simultaneously with Recon

Primary Search - is a quick search of structures likely to contain survivors. Primary searches are ground or waterborne operations conducted by walking or boating around every structure looking for victims. This is accomplished by looking into every window/opening, knocking on doors and hailing for live victims. If there are signs of victims (dead or alive) appropriate action will be taken based on the incident objectives. Other considerations for Primary Search are;

- Fast paced, quick scan of surface debris in and around structures and selected voids
- Size and makeup of the search team is incident driven and flexible
- Detection resources may include physical, canine and technical
- Known locations of live or deceased victims will be recorded and appropriate rescue or recovery resources will be requested
- Actions necessary to immediately correct life threatening injuries may be performed by this team
- Searched structures will be marked utilizing the Search Marking System (pg 63-66)
- Victim locations will be marked utilizing the Victim Marking System (pg 63-66)

Secondary Search - is the systematic search of every room of every structure in the assigned area of operation. Forced entry of structures may need to occur in order to accomplish this objective but will only be done with the authority of the Incident

Commander. This may involve extensive debris removal of building materials depending on the desired level of coverage and thoroughness.

- Slow and methodical search of structures, debris, and voids
- Size and makeup of the search team is incident driven and flexible
- Detection resources may include physical, canine and technical
- Known locations of live or deceased victims will be recorded and appropriate rescue or recovery resources will be requested
- Actions necessary to immediately correct life threatening injuries may be performed by this team
- Searched structures will be marked utilizing the Search Marking System (pg 63-66)
- Victim locations will be marked utilizing the Victim Marking System (pg 63-66)

Special Response Search - SRS is a search implemented to gather information regarding the need for evacuation or rescue of pre-identified special needs populations. SRS may be conducted pre or post incident at these pre-identified locations. .

Search Modes

DETECTION MODE - A search mode to determine if victims are present.

LOCATION MODE - Following detection, a search mode to confirm victim's location and pinpoint for rescue.

HEAVY EQUIPMENT RESOURCE TYPING

RESOURCE	COMPONENT	TYPE			
		Type 1	Type 2	Type 3	Type 4
Hydraulic Truck Crane	Rating (Tons) Radius (Feet)	100 ton+ Up to 275 feet	50-100 ton Up to 200 feet	Up to 50 ton Up to 150 feet	
Hydraulic Rough Terrain Crane	Rating (Tons) Radius (Feet)	Up to 50 ton Up to 100 feet			
Conventional Truck Crane	Rating (Tons) Radius (Feet)	150 ton+ Up to 300 feet	75-150 ton Up to 250 feet	Up to 75 ton Up to 150 feet	
Conventional Crawler Crane	Rating (Tons) Radius (Feet)	350 ton+ Up to 350+ feet	100-350 ton Up to 275 feet	Up to 100 ton Up to 160 feet	
Excavator Crawler	Rating (Lbs.) Reach	80k lbs.+ Up to 70 feet	40-80k lbs. Up to 50 feet	Up to 40k lbs. Up to 40 feet	Mini
Loader Rubber Tire	Rating (Cubic Yards)	5 cubic yards	3-5 cubic yards	1-3 cubic yards	Backhoe Skid Steer Mini
Forklift Conventional	Rating (Tons)	25 ton+	10-25 ton	5-10 ton	
Forklift All-Terrain Extendable	Rating (Lbs.)	3-6 tons (6-12k lbs.)			

GLOSSARY OF TERMS

Chemical Light and Flagging Tape Plan. A standardized marking system using chemical lights and colored flagging tape in conjunction with search, building and victim marking for low light and night operations.

Confined Space Rescue. Rescue operations in an enclosed area, with limited access/egress, not designed for human occupancy and has the potential for physical, chemical or atmospheric injury.

Emergency Signaling System. Loud, identifiable and prearranged signals sounded to alert personnel at the incident site of hazardous conditions or information that requires immediate attention.

Heavy Floor Construction. Structures in this general construction category are typically built utilizing Cast-in-Place (CIP) concrete construction consisting of heavy, concrete floors. Steel reinforcing bars (rebar) are most commonly used to provide the tension resistance within each concrete member, but post-tensioned steel cables may also be employed. These structures may be built utilizing concrete beam/column frame to provide "Moment Frame" resistance or concrete shear walls to provide "Box Type" resistance to earthquake forces and strong winds. Heavy Floor Construction may include any occupancy type. Occupancies most often found are offices, schools, apartments, hospitals, hotels, parking structures and multi-purpose facilities. Highway bridges and overpasses are a special form of very heavy floor construction.

Heavy Wall Construction. Structures in this general construction category are "Box Type" structures typically built with heavy, fire resistant exterior walls and lightweight wood floors and roof. The exterior walls are constructed of Reinforced Masonry (RM), Unreinforced Masonry (URM), or Tilt-up Concrete (TU). The adequacy of the interconnection of the walls and floors plus roof usually determines how well these structures resist the effects of earthquake forces and strong winds. State law in California requires URM structures be strengthened to reduce the collapse potential of these vulnerable walls in major earthquakes. Heavy Wall Construction occupancies may include office, commercial, educational (gymnasiums), industrial and warehouse buildings as well as multi-family residential and institutional structures.

High Angle Rope Rescue. An environment in which the load is predominately supported by the rope rescue system.

Highline System. A system using rope suspended between two points for movement of persons or equipment over an area that is a barrier to the rescue operation, including systems capable of movement between points of equal or unequal height.

Light Frame Construction. Structures in this general construction category are typically built with a vertical load resisting system of closely spaced wood or light gauge metal studs for bearing walls and joists for floors and rafters for roof. The lateral resistance is provided by wall and floor sheathing, which enables these "Box Type" structures to remain square and plumb providing a high degree of structural flexibility to applied lateral forces from earthquakes and strong winds. Light Frame Construction

occupancies may include single family and multi-unit residential buildings, low-rise commercial, institutional, and light industrial.

Low Angle Rope Rescue. An environment in which the load is predominately supported by itself and not the rope rescue system (e.g., flat land or mild sloping surface).

Pre-cast Concrete Construction. Structures in this general construction category are typically built utilizing modular pre-cast concrete components that include floors, walls, beams, columns and other sub-components that are field connected upon placement on site. Floor and roof components are normally reinforced using pre-tensioned steel cables that are bonded to the concrete as it is cast around the cables in the pre-casting factory. Individual concrete components utilize imbedded steel weldments and cast-in-place, topping slabs for the interconnection that provides for structural stability. These interconnections are very critical, since inadequate ones have led to widespread collapse problems during past earthquakes. These structures are usually built using a regular grid of columns and beams and most often have concrete or masonry shear walls to provide "Box Type" resistance to earthquake forces and strong winds. Pre-cast Concrete Construction occupancies may include commercial, office and multi-use or multi-function structures including parking structures and other large facilities. Highway bridges and overpasses may be constructed using pre-cast concrete segments, or using pre-cast beams in combination with cast-in-place concrete slabs.

Protective system. A method of protecting employees from cave-ins, from material that could fall or roll from an excavation face or into an excavation, or from the collapse of adjacent structures. Protective systems include support systems, sloping and benching, shield systems, and other systems that provide the necessary protection as per California Code of Regulations, Title 8, Section 1540. Excavation

Regional US&R Task Force. A 29-person team specially trained and equipped for large or complex US&R operations. The multi-disciplinary organization provides five functional elements that include Supervision, Search, Rescue, Medical, and Logistics. The make up of the Regional US&R Task Force consists of technically trained personnel based around a single Type I US&R Company. The Regional US&R Task Force is totally self-sufficient for the first 24 hours. Transportation and logistical support is provided by the sponsoring agency and may be supported by the requesting agency.

Search Marking System. A standardized marking system employed during and after the search of a structure for potential victims.

State/National US&R Task Force. A 70-person team specially trained and equipped for large or complex US&R operations. The multi-disciplinary organization provides seven functional elements that include Supervision, Search, Rescue, Haz-Mat, Medical, Logistics and Planning. The State/National US&R Task Force is designed to be used as a "single resource". However, each element of the Task Force is modularized into functional components and can be independently requested and utilized. A State/National US&R Task Force is accompanied by an Incident Support Team (IST) when deployed out of state. The IST provides overhead management and logistical

support to the US&R Task Force while on deployment. State/National US&R Task Forces responding from other states will work with the local incident command structure through the IST.

Steel Frame Construction. Structures in this general construction category are typically built using some type of steel beam and column system that is configured in a grid pattern. Lateral resistance against earthquake and severe wind forces is provided either by specially designed frames or diagonal bracing. Steel Frame Construction occupancies may include Prefabricated Metal buildings mostly one story, light industrial buildings; Low Rise, non-fireproofed buildings and other structures that include one and two story commercial, office, large industrial facilities, institutional structures, and convention and sports arenas with high, exposed roof systems; and High Rise, multi-story fireproofed buildings configured with fire sprinklers, standpipes, smoke proof stairs, and other fire protection systems. Fireproofing may consist of sprayed on fiber, layers of gypsum board, or in older buildings, concrete and masonry encasement.

Structure/Hazards Marking System. A standardized marking system to identify structures in a specific area and any hazards found within or near the structure.

US&R Company. Any ground vehicle(s) providing a specified level of US&R operational capability, rescue equipment and personnel.

US&R Crew. A predetermined number of individuals with common communications and a leader, organized and trained for a specified level of US&R operational capability. They respond with no rescue equipment and are used to relieve or increase the number of US&R personnel at an incident.

The US&R Type-4 Company (Basic: 3 personnel minimum) Operational Level represents the minimum capability to conduct safe and effective search and rescue operations at incidents involving non-structural entrapment in non-collapsed structures.

The US&R Type-3 Company (Light: 3 personnel minimum) Operational Level represents the minimum capability to conduct safe and effective search and rescue operations at structure collapse incidents involving the collapse or failure of Light Frame Construction and low angle or one-person load rope rescue.

The US&R Type-2 Company (Medium: 6 personnel minimum) Operational Level represents the minimum capability to conduct safe and effective search and rescue operations at structure collapse incidents involving the collapse or failure of Heavy Wall Construction, high angle rope rescue (not including highline systems), and trench and excavation rescue.

The US&R Type-1 Company (Heavy: 6 personnel minimum) Operational Level represents the minimum capability to conduct safe and effective search and rescue operations at structure collapse incidents involving the collapse or failure of Heavy Floor, Pre-cast Concrete and Steel Frame Construction, high angle rope rescue (including highline systems), confined space rescue (permit required), and mass transportation rescue.

Victim Marking System. A standardized marking system employed to identify the confirmed or potential location of a victim not readily visible and/or not immediately removed.

APPENDIX-A

FIVE GENERAL CONSTRUCTION CATEGORIES

Identifying the general construction category of a structure that has experienced a collapse or failure will help determine the appropriate US&R operational capability required to mitigate the incident. The five general construction categories the rescuer will most likely encounter in collapse or failure situations are light frame, heavy wall, heavy floor, pre-cast concrete, and steel frame. Several common structures are built utilizing a combination of these general construction categories such as light frame multi-unit residential structures built on top of a one or more story concrete parking garage, reinforced with steel reinforcing bars (rebar) or post-tensioned cables and steel frame buildings constructed on top of concrete commercial and/or parking structures.

Light Frame Construction (Wood and Light Metal Stud)

Structures in this general construction category are typically built with a vertical load resisting system of closely spaced wood or light gauge metal studs for bearing walls and joists for floors and rafters for roof. The lateral resistance is provided by wall and floor sheathing, which enables these “Box Type” structures to remain square and plumb providing a high degree of structural flexibility to applied lateral forces from earthquakes and strong winds.

These buildings are configured as follows:

Roof:	Wood or metal rafters or trusses spaced 16” to 32”o.c. Sheathing may be spaced or solid boards laid straight or diagonally, or plywood.
Floors:	Wood or metal joists or flat trusses spaced 12” to 24”o.c. Sheathing may be wood boards laid straight or diagonally, or plywood. Floors of newer construction may have 1” or 2” concrete topping over plywood sheathing.
Exterior Walls:	Wood or metal studs spaced 16” to 24”o.c. Sheathing may consist of wood boards laid straight or diagonally, or plywood. For smaller and older buildings, lath and plaster, or gypsum board is used for sheathing.
Interior Walls and Columns:	Most have walls with wood or metal studs spaced 16” to 24”o.c. that are sheathed with any of the types listed for exterior walls. Wood lath and gypsum plaster were used in older wood buildings. Larger buildings of this type may include column and beam framing in addition to the stud bearing walls.
Number of Stories:	Up to 4 stories for wood stud multi-unit residential buildings. Up to 6 stories for metal stud multi-unit residential and mixed-use buildings.
Occupancy Types:	May include single family and multi-unit residential buildings; plus low-rise commercial, institutional, and light industrial.

Heavy Wall Construction

(Exterior walls of Reinforced Masonry (RM), Unreinforced Masonry (URM), and Tilt-up Concrete (TU))

Structures in this general construction category are “Box Type” structures typically built with heavy, fire resistant exterior walls and lightweight wood floors and roof. The exterior walls are constructed of Reinforced Masonry (RM), Unreinforced Masonry (URM), or Tilt-up Concrete (TU). The adequacy of the interconnection of the walls and floors plus roof usually determines how well these structures resist the effects of earthquake forces and strong winds. State law in California requires URM structures be strengthened to reduce the collapse potential of these vulnerable walls in major earthquakes.

These buildings are configured as follows:

Roof:	URM usually has wood rafters or nailed wood trusses made from 2x, and 1x members that are sheathed with straight 1x wood sheathing. Bowstring (curved top with flat bottom) and other trusses were also used for main roof supports, with 2x joist, and 1x straight sheathing. Tilt-Up usually built with panelized system with long span glued-laminated (glulam) wood beams, 4x purlins, 2x sub-purlins and plywood sheathing or other lightweight roof systems.
Floors:	URM usually has 2x or 3x wood joist with straight 1x wood sheathing Tilt-Up usually built using large wood joist or flat wood trusses with plywood sheathing.
Exterior Walls:	URM walls usually have 9” thick parapet walls, and 4” is added to the thickness for each story in height. A typical two story URM building will have 13” thick walls and a 9” thick parapet wall. Tilt-Up walls are reinforced concrete, 6” or greater in thickness. They are cast flat on site in approximately 24’ widths and tilted into position.
Interior Columns and Walls:	URM may have wood stud walls. Large wood columns and beams may also be used. There may or may not be a uniform grid layout. Tilt-Up usually has steel pipe/tube columns spaced in a 24’ on center by 50’ or similar spacing. They most always have a uniform structural grid. Buildings with long-span trusses may have no interior columns.
Number of Stories:	URM up to 8 stories high, but most are 2 stories or less Tilt-Ups are mostly one story, up to 24’ high. Some may be 2 or 3 story with up to 40’ high walls.
Occupancy Types:	URM may include occupancies as in Tilt-Ups as well as multi-family residential and institutional structures. Tilt-Ups may include office, commercial, educational (gymnasiums), or industrial and warehouse buildings.

Heavy Floor Construction (Cast-in-Place Concrete)

Structures in this general construction category are typically built utilizing Cast-in-Place Concrete (CIP) construction consisting of heavy, concrete floors. Steel reinforcing bars (rebar) are most commonly used to provide the tension resistance within each concrete member, but post-tensioned steel cables may also be employed. These structures may be built utilizing concrete beam/column frame to provide “Moment Frame” resistance or concrete shear walls to provide “Box Type” resistance to earthquake forces and strong winds.

These buildings are configured as follows:

Roof and Floors:	Concrete slabs with beams, concrete joist with girders, and waffle or two-way flat slab assemblies.
Exterior Columns and Walls:	Concrete “Moment Frame” structures use reinforced concrete columns as the main exterior supports. The spaces between columns are enclosed with infill or panel walls of glass in metal frames, metal studs and plaster, brick, brick or stone veneer on metal studs, and pre-cast concrete panels. Combinations of these materials may also be used. In older and non-west coast buildings, infill walls may be constructed using very brittle materials such as URM and hollow clay tile. These structures are very vulnerable to earthquake damage. “Box Type” structures may have some concrete columns with infill walls as with concrete framed structures, but reinforced concrete, shear walls are used for the main exterior walls.
Interior Columns and Walls:	Both concrete framed and Box Types may have a grid of concrete columns, and interior spaces are divided using non-structural walls constructed using metal studs and gypsum board, or URM. Box Type structures often have interior concrete shear walls.
Number of Stories:	Heights vary from single story to high-rise structures.
Occupancy Types:	May include any occupancy type. Occupancies most often found are offices, schools, apartments, hospitals, hotels, parking structures and multi-purpose facilities. Highway bridges and overpasses are a special form of very heavy floor construction.

Pre-cast Concrete Construction

Structures in this general construction category are typically built utilizing modular pre-cast concrete components that include floors, walls, beams, columns and other sub-components that are field connected upon placement on site. Floor and roof components are normally reinforced using pre-tensioned steel cables that are bonded to the concrete as it is cast around the cables in the pre-casting factory. Individual concrete components utilize imbedded steel weldments and cast-in-place, topping slabs for the interconnection that provides for structural stability. These interconnections are very critical, since inadequate ones have led to widespread collapse problems during past earthquakes. These structures are usually built using a regular grid of columns and beams, and most often have concrete or masonry shear walls to provide “Box Type” resistance to earthquake forces and strong winds.

These buildings are configured as follows:

Roof and Floors:	Single and double “T” components are used in longer span systems to span between pre-cast beams. Hollow core or solid concrete planks are used to span shorter distances between beams or walls. Cast-in-place (rebar or post-tensioned) concrete slabs over pre-tensioned pre-cast concrete girders are often used in garages and office buildings.
Exterior Columns and Walls:	Pre-cast concrete columns are often used as the main exterior supports. The spaces between columns may be enclosed with infill or panel walls of glass in metal frames, metal studs and plaster, reinforced masonry shear walls, brick or stone veneer on metal studs, and pre-cast concrete panels. Combinations of these materials may also be used. Pre-cast concrete frames, as well as cast-in-place concrete shear walls, have been used as the main exterior supports for these structures.
Interior Columns and Walls:	A grid of pre-cast concrete, or steel columns is usually used to support the beams and girders. Interior spaces may be divided using non-structural walls constructed using metal studs and gypsum board, or concrete masonry unit (CMU) blocks. Non-structural walls in non-west coast types may employ URM.
Number of Stories:	Heights vary from single story to high-rise structures.
Occupancy Types:	May include commercial, office and multi-use or multi-function structures including parking structures and large occupancy facilities. Highway bridges and overpasses may be constructed using pre-cast concrete segments, or using pre-cast beams in combination with cast-in-place concrete slabs.

Steel Frame Construction

Structures in this general construction category are typically built using some type of steel beam and column system that is configured in a grid pattern. Lateral resistance against earthquake and severe wind forces is provided either by specially designed frames or diagonal bracing.

These buildings are configured as follows:

Roof:	Roof purlins and beams comprised of solid steel or light steel “Bar Joists” that are sheathed with corrugated metal deck. In all but some prefab types the sheathing is covered with insulation to form a flat surface. Purlins, beams, and bar-joists are supported by steel girders or trusses. Some steel frame structures may have wood sheathing, joists and beams that are supported by steel girders and/or trusses.
Floors:	Floors are normally built using concrete fill on corrugated metal deck, but in some cases, pre-cast concrete planks, or even wood truss joists with plywood sheathing may be used. Solid steel beams and steel trusses normally are used to span between the steel girders.
Exterior Columns and Walls:	Steel columns are the main exterior supports. The spaces between columns may be enclosed with infill/panel walls of glass in metal frames, metal studs and plaster, brick or stone veneer on metal studs, metal siding, and pre-cast concrete panels. Combinations of these materials may also be used. In older and non-west coast buildings, infill walls may be constructed using very brittle materials such as URM, terra cotta tiles, and hollow clay tiles.
Interior Columns and Walls:	A grid of steel columns is usually used to support the beams and girders. Interior spaces may be divided using non-structural walls constructed using metal studs and gypsum board. Non-structural walls may employ URM.
Occupancy Types:	Prefabricated metal buildings include mostly one story, light industrial buildings. Low Rise, non-fireproofed buildings and other structures include one and two story commercial, office, large industrial facilities, institutional structures, and convention and sports arenas with high, exposed roof systems. High Rise, fireproofed buildings include multi-story structures configured with fire sprinklers, standpipes, smoke proof stairs, and other fire protection systems. Fireproofing may consist of sprayed on fiber, layers of gypsum board, or in older buildings, concrete and masonry encasement.

APPENDIX-B

FOUR LEVELS OF US&R OPERATIONAL CAPABILITY

The US&R Type-4 Company (Basic: 3 personnel minimum) Operational Level represents the minimum capability to conduct safe and effective search and rescue operations at incidents involving non-structural entrapment in non-collapsed structures.

The US&R Type-3 Company (Light: 3 personnel minimum) Operational Level represents the minimum capability to conduct safe and effective search and rescue operations at structure collapse incidents involving the collapse or failure of Light Frame Construction and low angle or one-person load rope rescue.

The US&R Type-2 Company (Medium: 6 personnel minimum) Operational Level represents the minimum capability to conduct safe and effective search and rescue operations at structure collapse incidents involving the collapse or failure of Heavy Wall Construction, high angle rope rescue (not including highline systems), and trench and excavation rescue.

The US&R Type-1 Company (Heavy: 6 personnel minimum) Operational Level represents the minimum capability to conduct safe and effective search and rescue operations at structure collapse incidents involving the collapse or failure of Heavy Floor, Pre-cast Concrete and Steel Frame Construction, high angle rope rescue (including highline systems), confined space rescue (permit required), and mass transportation rescue.

APPENDIX-C

FOUR LEVELS OF US&R OPERATIONAL CAPABILITY

MINIMUM TRAINING

US&R Type-4 (Basic) Operational Level

Personnel shall be trained in hazard recognition, equipment use and techniques required to operate safely and effectively at incidents involving non-structural entrapment. Personnel at this level shall be competent at surface rescue that involves minimal removal of debris and building contents to extricate easily accessible victims from damaged, but non-collapsed structures.

Training at the basic level should at a minimum include the following:

- A. Size-up of existing and potential conditions and the identification of the resources necessary to conduct safe and effective urban search and rescue operations.
- B. Process for implementing the Incident Command System (ICS).
- C. Procedures for the acquisition, coordination and utilization of resources.
- D. Procedures for implementing site control and scene management.
- E. Identification, utilization and proper care of personal protective equipment required for operations at structural collapse or failure incidents.
- F. Identification of five general construction categories, characteristics and expected behavior of each category in a collapse or failure situation.
- G. Identification of four types of collapse patterns and potential victim locations.
- H. Recognition of the potential for secondary collapse.
- I. Recognition of the general hazards associated with a structure collapse or failure situation and the actions necessary for the safe mitigation of those hazards.
- J. Procedures for implementing the structure/hazard marking system.
(Appendix-G)
- K. Procedures for conducting searches at non-collapsed structures using appropriate methods for the type of building configuration.

- L. Procedures for implementing the search marking system. (Appendix-H)
- M. Recognition and response to the emergency signaling system (Appendix-J)
- N. Procedures for the extrication of easily accessible victims from non-structural entrapments involving minimal removal of debris and /or building contents.
- O. Procedures for providing disaster first aid medical care to victims.
- P. Members shall be trained to the Hazardous Materials First Responder Awareness Level (FRA).

US&R Type-3 (Light) Operational Level

Personnel shall meet all US&R Type-4 (Basic) level training requirements. In addition, personnel shall be trained in hazard recognition, equipment use and techniques required to operate safely and effectively at structural collapse incidents involving the collapse or failure of Light Frame Construction and low angle or one person load rope rescue as specified below:

- A. Personnel shall be trained to recognize, evaluate and communicate the unique hazards associated with the collapse or failure of Light Frame Construction. Training should include but not be limited to the following:
 - 1. Site safety, hazard assessment and personal protective equipment required for site.
 - 2. Recognition of the building materials and structural components associated with Light Frame Construction.
 - 3. Recognition of unstable collapse and failure zones of Light Frame Construction.
 - 4. Recognition of collapse patterns and probable victim locations associated with Light Frame Construction.
 - 5. Procedures for implementing the emergency signaling system. (Appendix-J)

- B. Personnel shall have an awareness of the resources and the ability to perform search operations intended to locate victims who are not readily visible and who are trapped inside and beneath debris of Light Frame Construction. Training should include but not be limited to the following:
 - 1. Conducting non-technical searches.
 - 2. Procedures for implementing the victim marking system. (Appendix-I)
 - 3. Capabilities and procedures for requesting US&R canine search team and technical search equipment such as video and optical visual search devices and seismic or acoustic electronic listening devices.

- C. Personnel shall be trained in the procedures for performing access operations intended to reach victims trapped inside and beneath debris associated with Light Frame Construction. Training should include but not be limited to the following:
1. Lifting techniques to safely and efficiently lift structural components of walls, floors or roofs.
 2. Develop and communicate a shoring plan. Safely and efficiently construct temporary structures needed to stabilize and support structural components to prevent movement of walls, floors or roofs.
 3. Breaching techniques to safely and efficiently create openings in structural components of walls, floors or roofs.
 4. Operating appropriate tools and equipment to safely and efficiently accomplish the above tasks.
- D. Personnel shall be trained in the procedures for performing extrication operations involving packaging, treatment and removal of victims trapped inside and beneath debris associated with Light Frame Construction. Training should include but not be limited to the following:
1. Packaging victims within confined areas.
 2. Removing victims from elevated or below grade areas.
 3. Providing medical treatment to victims at a minimum to the Basic Life Support (BLS) level.
 4. Operating appropriate tools and equipment to safely and efficiently accomplish the above tasks.
- E. Personnel shall be trained in the procedures for performing low angle or one-person load rope rescue involving accessing, packaging, treating, and removing victims. Training should include but not be limited to the following:
1. Rope system anchors
 2. Evacuation litters
 3. Rescuer and patient packaging
 4. Lowering and raising systems
 5. Mechanical advantage systems

US&R Type-2 (Medium) Operational Level

Personnel shall meet all US&R Type-3 (Light) level training requirements. In addition, personnel shall be trained in hazard recognition, equipment use and techniques required to operate safely and effectively at structural collapse incidents involving the collapse or failure of Heavy Wall Construction, high angle rope rescue (not including highline systems), and trench and excavation rescue as specified below:

- A. Personnel shall be trained to recognize, evaluate and communicate the unique hazards associated with the collapse or failure of Heavy Wall Construction. Training should include but not be limited to the following:
 - 1. Site safety; atmospheric monitoring, hazard assessment and personal protective equipment required for site.
 - 2. Recognition of the building materials and structural components associated with Heavy Wall Construction.
 - 3. Recognition of unstable collapse and failure zones of Heavy Wall Construction.
 - 4. Recognition of collapse patterns and probable victim locations associated with Heavy Wall Construction.
- B. Personnel shall have a working knowledge of the resources and procedures for performing search operations intended to locate victims who are not readily visible and who are trapped inside and beneath debris of Heavy Wall Construction.
- C. Personnel shall be trained in the procedures for performing access operations intended to reach victims trapped inside and beneath debris associated with Heavy Wall Construction. Training should include but not be limited to the following:
 - 1. Lifting techniques to safely and efficiently lift structural components of walls, floors or roofs.
 - 2. Develop and communicate a shoring plan. Safely and efficiently construct temporary structures needed to stabilize and support structural components to prevent movement of walls, floors or roofs.
 - 3. Breaching techniques to safely and efficiently create openings in structural components of walls, floors or roofs.
 - 4. Operating appropriate tools and equipment to safely and efficiently accomplish the above tasks.

- D. Personnel shall be trained in the procedures for performing extrication operations involving packaging, treatment and removal of victims trapped inside and beneath debris associated with Heavy Wall Construction. Training should include but not be limited to the following:
1. Packaging victims within confined areas.
 2. Removing victims from elevated or below grade areas.
 3. Operating appropriate tools and equipment to safely and efficiently accomplish the above tasks.
- E. Personnel shall be trained in the procedures for performing high angle rescue (not including highline systems) involving accessing, packaging, treating, and removing victims. Training should include but not be limited to the following:
1. Rope system anchors
 2. Evacuation litters
 3. Rescuer and patient packaging
 4. Lowering and raising systems
 5. Mechanical advantage systems
 6. Fall protection and/or limiter system

F. Personnel shall be trained in the procedures for performing trench and excavation rescue operations. Training shall include but not be limited to the following:

1. Familiarity with the California Code of Regulations, Title 8, Section 1540, 1541 and 1541.1.
2. Site safety; atmospheric monitoring, hazard recognition and hazard assessment.
3. Containing or controlling hazards within the rescue site.
4. Providing a recognized "Protective System" for victim(s) and rescuer(s) in individual trenches.
5. Packaging and removal of victim(s) from within rescue site.

G. Members shall be trained to the Hazardous Materials First Responder Operational Level (FRO).

H. Members shall be trained in appropriate response procedures for incidents involving weapons of mass destruction (WMD).

US&R Type-1 (Heavy) Operational Level

Personnel shall meet all US&R Type-2 (Medium) level training requirements. In addition, personnel shall be trained in hazard recognition, equipment use and techniques required to operate safely and effectively at structural collapse incidents involving the collapse or failure of Heavy Floor, Pre-cast Concrete and Steel Frame Construction, high angle rope rescue (including highline systems), confined space rescue (permit required) and mass transportation rescue.

- A. Personnel shall be trained to recognize, evaluate and communicate the unique hazards associated with the collapse or failure of Heavy Floor, Pre-cast Concrete and Steel Frame Construction. Training should include but not be limited to the following:
 - 1. Site safety; atmospheric monitoring, hazard assessment and personal protective equipment required for site.
 - 2. Recognition of the building materials and structural components associated with Heavy Floor, Pre-cast Concrete and Steel Frame Construction.
 - 3. Recognition of unstable collapse and failure zones of Heavy Floor, Pre-cast Concrete and Steel Frame Construction.
 - 4. Recognition of collapse patterns and probable victim locations associated with Heavy Floor, Pre-cast Concrete and Steel Frame Construction.

- B. Personnel shall have a working knowledge of the resources and procedures for performing search operations intended to locate victims who are not readily visible and who are trapped inside and beneath debris of Heavy Floor, Pre-cast Concrete and Steel Frame Construction.

- C. Personnel shall be trained in the procedures for performing access operations intended to reach victims trapped inside and beneath debris associated with Heavy Floor, Pre-cast Concrete and Steel Frame Construction. Training should include but not be limited to the following:
 - 1. Lifting techniques to safely and efficiently lift structural components of walls, floors or roofs.
 - 2. Develop and communicate a shoring plan. Safely and efficiently construct temporary structures needed to stabilize and support structural components to prevent movement of walls, floors or roofs.
 - 3. Breaching techniques to safely and efficiently create openings in structural components of walls, floors or roofs.

4. Operating appropriate tools and equipment to safely and efficiently accomplish the above tasks.
- D. Personnel shall be trained in the procedures for performing extrication operations involving packaging, treatment and removal of victims trapped inside and beneath debris associated with Heavy Floor, Pre-cast Concrete and Steel Frame Construction. Training should include but not be limited to the following:
1. Packaging victims within confined areas.
 2. Removing victims from elevated or below grade areas.
 3. Operating appropriate tools and equipment to safely and efficiently accomplish the above tasks.
- E. Personnel shall be trained in the procedures for performing high angle rescue (including highline systems) involving accessing, packaging, treating, and removing victims. Training should include but not be limited to the following
1. Rope system anchors
 2. Evacuation litters
 3. Rescuer and patient packaging
 4. Lowering and raising systems
 5. Mechanical advantage systems
 6. Fall protection and/or limiter system
- F. Personnel shall be trained in the procedures for performing confined space rescue (permit required) operations. Training shall include but not be limited to the following:
1. Site safety: atmospheric monitoring, hazard recognition and hazard assessment in permit-required confined spaces, tunnels or other long remote entries, high vertical access and hazardous environmental entries.
 2. Containing and controlling hazards within the rescue site.
 3. Packaging and removal of victims within confined spaces.

- G. Personnel shall be trained in the procedures for performing extrication operations involving packaging, treating, and removing victims trapped within mass transportation systems. Training should include but not limited to the following:
1. Procedures to conduct a size-up of existing and potential hazards.
 2. Recognition of special hazards, safety systems and construction of transportation systems.
 3. Packaging and removal of victim(s) from within rescue site.
 4. Extrication techniques to safely and efficiently gain access to trapped victims.
 5. Procedures to safely and efficiently stabilize, support, and lift different types of transportation vehicles.
 6. Operating specialized tools and equipment to safely and efficiently accomplish the above tasks.

**APPENDIX-D
FOUR LEVELS OF US&R OPERATIONAL CAPABILITY
MINIMUM EQUIPMENT LIST**

These lists identify the minimum amount of tools and equipment needed to provide a safe and acceptable level of service for each of the four levels of US&R operational capability.

UNIT	MINIMUM EQUIPMENT LIST DESCRIPTION	Typing Level			
		T4	T3	T2	T1
	<u>Breaking and Breaching</u>				
Ea	Demolition Hammer Kit, Lg (<i>see tool info sheet</i>)	0	0	1	2
Ea	Demolition Hammer Kit, Sm (<i>see tool info sheet</i>)	0	0	1	2
Ea	Drill Kit, ½ " (<i>see tool info sheet</i>)	0	0	0	1
Ea	Rotary Hammer Kit (<i>see tool info sheet</i>)	0	0	1	2
	<u>Communication</u>				
Ea	Portable Radio Kit (<i>see tool info sheet</i>)	0	1	6	6
	<u>Confined Space</u>				
Ea	Atmospheric Monitor Kit (<i>see tool info sheet</i>)	0	0	1	3
Ea	Communication Kit (<i>see tool info sheet</i>)	0	0	0	1
Ea	Extrication Stretcher (confined areas)	0	0	0	1
Ea	Lock-out Tag-out capability	0	0	1	1
Ea	Supplied Air Breathing Apparatus, SABA/SAR (<i>see tool info sheet</i>)	0	0	0	4
Ea	Tri Pod Kit (<i>see tool info sheet</i>)	0	0	0	1
Ea	Ventilation Fan (<i>see tool info sheet</i>)	0	0	1	2
	<u>Cutting</u>				
Ea	Air Chisel Kit (<i>see tool info sheet</i>)	0	0	0	1
Ea	Chain Saw Kit, Electric (<i>see tool info sheet</i>)	0	0	0	1
Ea	Chain Saw Kit, Gasoline (<i>see tool info sheet</i>)	0	1	1	2
Ea	Circular Saw Kit, 10 ¼" min. (<i>see tool info sheet</i>)	0	0	1	1
Ea	Cutting Torch (<i>see tool info sheet</i>)	0	0	0	1
Ea	Rebar Cutter, (¾") (<i>see tool info sheet</i>)	0	0	0	1
Ea	Reciprocating Saw Kit, Cordless (<i>see tool info</i>)	0	0	1	2
Ea	Reciprocating Saw Kit, Electric (<i>see tool info</i>)	0	0	1	2
Ea	Rotary Saw Kit, 14"/ 16" gasoline (<i>see tool info sheet</i>)	0	0	1	2
Ea	Water Can, Pressurized	0	0	1	2
	<u>Detection</u>				

MINIMUM EQUIPMENT LIST		Typing Level			
UNIT	DESCRIPTION	T4	T3	T2	T1
Ea	Electrical Detection Device <i>(see tool info sheet)</i>	0	0	1	1
<u>Electrical</u>					
Ea	Electrical Adapter Kit <i>(see tool info sheet)</i>	0	0	1	2
Ea	Floodlights, Portable (500 watt)	0	0	4	8
Ea	Generator, <u>Portable</u> 5kw min., 5 gal. of fuel in safety fuel can(s) or multiple generators <i>in series</i> which meet 30 amperage requirement. (see tool information sheet)	0	0	1	0
Ea	Generator, <u>Portable or Fixed</u> 5kw min. 5 gal. of fuel in safety fuel can(s) or multiple generators <i>in series</i> which meet 30 amperage requirement. (maximum of 1 fixed generator) <i>(see tool information sheet)</i>	0	0	0	2
<u>Extrication Tools</u>					
Ea	Hydraulic Rescue Tool Kit <i>(see tool info sheet)</i>	0	0	0	1
<u>Hand Tools</u>					
Ea	Axes (pick head and/or flat head)	2	2	2	2
Ea	Bolt Cutter (30" minimum)	1	1	1	1
Ea	Bolt Cutter, Heavy Duty (minimum 42")	0	0	0	1
Ea	Chisel, Cold (1"x 7/8")	2	2	2	2
Ea	Crowbar, 36"	2	2	2	2
Ea	Hand Digging Tool, (maximum 12" handle)	0	0	2	2
Ea	Hand Saw, Crosscut (26")	2	2	2	2
Ea	Hacksaw (heavy duty)	2	2	2	2
Ea	Hacksaw Blades (carbide grit)	12	12	12	12
Ea	Long Handle 3 or 4 Tine Cultivator/Hoe (Minimum 48")	0	0	4	4
Ea	Pry Bar, Pinch Point (60')	4	4	4	4
Ea	Shovel Long Handle (round point)	0	1	1	1
Ea	Shovel, Long Handle (square point)	0	1	1	1
Ea	Shovel, Short Handle (compact folding, recommended with "D" handle)	0	0	2	4
Ea	Sledge Hammer (8-10 lb, long handle, "double jack")	2	2	2	2
Ea	Sledge Hammer, (2-4 lb, short handle, "single jack")	2	4	4	4
Ea	Tool Kit <i>(see tool info sheet)</i>	0	1	1	1
Ea	Utility Knife	1	2	2	2
<u>Lifting</u>					
Ea	Air Bag Kit, High Pressure, 195 ton <i>(see tool info sheet)</i>	0	0	0	1
Ea	Air Bag Kit, High Pressure, 50 ton <i>(see tool info)</i>	0	0	1	1

MINIMUM EQUIPMENT LIST		Typing Level			
UNIT	DESCRIPTION	T4	T3	T2	T1
Ea	Air Bag Kit, Low Pressure, 10 ton (<i>see tool info sheet</i>)	0	0	0	1
Ea	High Lift Jacks	0	0	2	2
Ea	Hydraulic Bottle Jacks (5 ton minimum)	0	2	2	2
<u>Medical</u>					
Ea	Backboard (with immobilization device)	0	1	1	1
Ea	Blanket (disposable)	2	2	2	2
Ea	First Aid Kit (<i>see tool info sheet</i>)	1	1	1	1
Ea	Trauma Kit (<i>see tool info sheet</i>)	0	1	1	1
<u>Miscellaneous</u>					
Roll	Duct Tape	0	2	2	14
Ea	Emergency Signaling Device (air horn or whistle)	3	3	6	6
Ea	Haul Bags or Buckets	0	2	6	6
<u>PPE</u>					
Roll	Chemical Protection Tape (for taping PPE)	0	0	0	2
Ea	Flame Resistant Garment (one or two piece)	0	0	6	6
Ea	Personal Alarm Device (PAL)	0	0	0	6
Ea	Personal Protective Equipment (<i>see tool info sheet</i>)	3	3	6	6
Ea	Personal Protective Equipment, WMD (<i>see tool info</i>)	0	0	0	6
Ea	Respirator, Air Purifying (half APR, P100 minimum)	0	0	6	6
Ea	Respirator Cartridges, Replacement (P100 minimum)	0	0	24	24
Ea	Self-Contained Breathing Apparatus with cylinder (SCBA)	0	0	0	6
Ea	Spare Cylinders (SCBA)	0	0	0	6
<u>Pulling</u>					
Ea	Chain Set (<i>see tool info sheet</i>)	0	0	1	1
Ea	Come Along (minimum 2 ton)	0	0	1	2
<u>Rope</u>					
Ea	Anchor Kit (<i>see tool info sheet</i>)	0	0	1	1
Ea	Carabiners (General use, NFPA approved)	0	15	27	40
Ea	Edge Protection (<i>see tool info sheet</i>)	0	2	2	2
Ea	Etrier	0	0	2	2
Ea	General use friction device with at least one Brake Bar Rack, (NFPA approved)	0	2	4	4
Ea	Harness (NFPA Class-III, if for a Type 1 Company, 2 must be confined space compliant)	0	3	6	6
Ea	Litter & Complete Pre-rig (<i>see tool info sheet</i>)	0	1	1	1

MINIMUM EQUIPMENT LIST		Typing Level			
UNIT	DESCRIPTION	T4	T3	T2	T1
Ea	Load Releasing Device (<i>see tool info sheet</i>)	0	2	4	4
Ea	Mechanical Ascender, (NFPA approved)(OPTIONAL)	0	2	2	2
Ea	Multi-point Collection Device (anchor plate)	0	2	2	2
Ea	Pickets, Minimum 6 Cold Rolled Steel Round Bar, 6 may be light weight, hollow with chisel or conical point, one end (1" diameter x 4' long)	0	12	12	18
Ea	Pick-Off Straps (<i>see tool info sheet</i>)	0	0	2	2
Ea	PPE Victim Kit (<i>see info sheet</i>)	0	1	1	1
Pr	Prusik Loops (Rope Specific, 6 long and 6 short, 8mm minimum)	0	6	12	18
Ea	Pulley, Knot Passing (General use, NFPA approved)	0	0	0	2
Ea	Pulley, Rescue (2" minimum or 4" All to be prusik minding)	0	3	6	18
Ea	Rope, Static Kernmantle (150' length minimum x ½" General use, NFPA approved)	0	2	2	2
Ea	Rope, Static Kernmantle (20'X1/2", General use, NFPA approved)	0	0	2	2
Ea	Rope, Static Kernmantle (300' length minimum x ½" General use, NFPA approved)	0	1	2	4
Ea	Webbing Kit (<i>see tool info sheet</i>)	0	1	2	3
<u>Search & Marking</u>					
Roll	Barrier Tape (fire line tape or equivalent)	1	2	14	14
Ea	Building Marking Kit (<i>see tool info sheet</i>)	1	1	2	3
Ea	Chemical Light Kit (<i>see tool info</i>)	1	2	3	4
Ea	GPS, Hand-Held	0	0	0	2
Ea	Visual Search Device (<i>see tool info sheet</i>)	0	0	0	1
<u>Stabilization & Shoring</u>					
Ea	Carpenter Belts (nail bags)	0	3	6	6
Ea	Cribbing & Wedge Kit (<i>see tool sheet</i>)	1	2	4	5
Ea	Double End 9"-15" metal nail puller (i.e. "cat's paw")	0	1	1	1
Ea	Ellis Clamps (4"x 4" post) (See Mechanical Shore options)	0	0	8	20
Ea	Ellis Jack (for Ellis clamps) (See Mechanical Shore options)	0	0	1	2
Ea	Ellis Post Screw Jack (4"x 4") (See Mechanical Shore options)	0	0	8	8
Ea	Framing Hammer (19 oz minimum)	0	3	6	6
Ea	Framing Square (24")	0	1	2	2
Ea	Level (4')	0	0	0	1
Ea	Level, 6 inch minimum ("torpedo level")	0	3	6	6
Ea	Lumber Kit (<i>see tool info sheet</i>)	0	0	1	2

MINIMUM EQUIPMENT LIST		Typing Level			
UNIT	DESCRIPTION	T4	T3	T2	T1
Ea	Mechanical Shoring Kit (see tool info sheet) (See Mechanical Shore options)	0	0	1	3
Ea	Nail Gun Kit, Framing (<i>see tool info sheet</i>)	0	0	0	1
Ea	Nail Gun Kit, Powder Actuated (<i>see tool info sheet</i>)	0	0	0	1
Ea	Nail Kit (<i>see tool info sheet</i>)	0	1	1	2
Ea	Tape Measure (25' minimum)	0	3	6	6
Ea	Tri or Speed Square	0	3	6	6
<u>Trench</u>					
Ea	Haul Buckets or Bags (metal, plastic, canvas)	0	0	4	4
Ea	Ladders (minimum 10')	0	0	2	2
Ea	Palm Nailer (battery or pneumatic – may use air bag regulator and air supply)	0	0	1	1

Page Intentionally Left Blank

US&R TOOL INFO SHEET (TIS)		
QTY	UNIT	DESCRIPTION
		Air Bag Kit (High Pressure, 50 ton)
2	Ea	Air Bag Hose (color coded)
1	Ea	Controller
3	Ea	HP Air Bags (50 ton minimum, total capability)
2	Ea	Inline Control Valve (shut off adapter)
1	Ea	Pressure Reducer Regulator
2	Ea	SCBA Bottle (Air Bag Kit Supply)
1	Ea	Supply Hose
		Air Bag Kit (High Pressure, 195 ton)
2	Ea	Air Bag Hose (color coded)
1	Ea	Controller
1	Set	HP Air Bag (125 ton minimum capability, any combination)
1	Ea	HP Air Bag (70 ton minimum, capability)
2	Ea	Inline Control Valve (shut off adaptor)
1	Ea	Pressure Reducer Regulator
1	Ea	Supply Hose
		Air Bag Kit (Low Pressure, 10 ton, not to exceed 14.5 psi)
2	Ea	Air Bag Hose (color coded)
1	Ea	Controller
2	Ea	LP Air Bags (minimum 5 ton capability, each bag)
1	Ea	Patch Kit
1	Ea	Pressure Reducer Regulator
1	Ea	Supply Hose
		Air Chisel Kit
1	Ea	Air Chisel
2	Ea	Bull Point Tips
2	Ea	Flat Chisel Tips
1	Ea	Hose (with couplings)
2	Ea	Panel Cutter Tips (double bladed)
1	Ea	Pressure Reducer Regulator
		Anchor Kit
25	Ea	Concrete Wedge Anchors (1/2"x 5 1/2")
25	Ea	Female Drop Forged H/D Eye Nuts (1/2"x course)
25	Ea	Bolt Hangers (rock climbing type, 1/2")
1	Ea	Torque Wrench (per manufactures specifications)

US&R TOOL INFO SHEET (TIS)		
QTY	UNIT	DESCRIPTION
		Atmospheric Monitor Kit
1	Ea	Air Monitor (minimum four gas sampling: Capability to include O2, LEL, CO and H2S with pump and sampling tube)
1	Ea	Calibration Kit (or one per model if not generic)
		Building Marking Kit
4	Roll	Flagging Tape (1", orange or red)
4	Ea	Lumber Chalk (stick)
2	Ea	Lumber Crayon (red)
2	Ea	Lumber Crayon (yellow)
4	Ea	Lumber Pencil
6	Ea	Spray Paint (orange)
		Chain Saw Kit
1	Ea	Bar (spare)
1	Ea	Bar Oil (gal)
1	Ea	Chain Saw, 12" minimum (gasoline or electric) with carbide chain
2	Ea	Chains, carbide (spare)
		Gasoline
1	Ea	Fuel Kit, Safety Fuel Can (2 ½ gal, with pre-mix) (see tool info sheet)
1	Ea	Maintenance Kit (spark plug, air filter and wrench)
		Electric
1	Ea	Extension Cord (100')
1	Ea	Wrench
		Chain Set (3/8, grade 7 minimum)
1	Ea	Chain (1' with a grab hook on each end)
1	Ea	Chain (5' with a grab & slip hook)
1	Ea	Chain (10' with a grab & slip hook)
1	Ea	Chain (20' with a grab & slip hook)
		Chemical Light Kit (Sticks)
4	Ea	Blue (8 hr minimum)
4	Ea	Green (8 hr minimum)
4	Ea	Red (8 hr minimum)
4	Ea	White (8 hr minimum)
4	Ea	Yellow (8 hr minimum)
		Circular Saw Kit
2	Ea	Carbide Saw Blade (10 ¼")
1	Ea	Circular Saw (10 ¼" blade)
		Communication Kit

US&R TOOL INFO SHEET (TIS)		
QTY	UNIT	DESCRIPTION
1	Ea	Cable & Headset (for operator, 20')
4	Ea	Cable sets (minimum 300' / total 1200')
1	Ea	Communication System (5 person, intrinsically safe, hard wire)
4	Ea	Face Mask Rescue Sets (speaker & mic)
		Cribbing and Wedge Kit
1	Ea	Container (to store and carry lumber)
8	Ea	Cribbing (2"x 4"x 18")
8	Ea	Cribbing (4"x 4"x18")
8	Pr	Wedges (2"x 4"x 12")
8	Pr	Wedges (4"x 4"x18")
		Cutting Torch (One or more of the following, w/ 1" thick or greater steel cutting capability)
1	Ea	Exothermic Torch (100 rods, spare O2 cylinder- minimum of 120 cf total)
1	Ea	Oxy/Acetylene Torch (heavy duty, with cylinders - minimum of 120 cf total)
1	Ea	Oxy/Gasoline Torch (spare O2 cylinder - minimum of 120 cf total, spare tip)
1	Ea	Plasma Cutter (with accessories)
		Demolition Hammer Kit (Small, one or more of the following)
2	Ea	Bull Points Bits
2	Ea	Chisel Point Bits
1	Ea	Demolition Hammer (35 – 45 lbs or equivalent, electric, hydraulic, pneumatic, or gasoline)
		Electric
1	Ea	Power Unit (50' hose)
		Pneumatic
1	Ea	Air Source (50' hose)
		Gasoline
1	Ea	Fuel Kit, (see tool info sheet)
1	Ea	Maintenance Kit (spark plug, air filter and wrench)
		Demolition Hammer Kit (Large, one or more of the following)
2	Ea	Bull Point Bits
2	Ea	Chisel Point Bits
1	Ea	Demolition Hammer (minimum 60lbs or equivalent, electric, hydraulic, pneumatic, or gasoline)
		Hydraulic
1	Ea	Power Unit (50' hose)
		Pneumatic
1	Ea	Air Source (50' hose)

US&R TOOL INFO SHEET (TIS)		
QTY	UNIT	DESCRIPTION
		Gasoline
1	Ea	Fuel Kit, (see tool info sheet)
1	Ea	Maintenance Kit (spark plug, air filter and wrench)
		Drill Kit (One or more of the following)
1	Ea	Drill (1/2", variable speed, electric)
1	Ea	Steel Bit Set (1/8" thru 1/2")
		Cordless
1	Ea	Charger
2	Ea	Spare Batteries
		Edge Protection Kit
2	Ea	Edge Protection (commercial rollers, canvas tarps, split fire hose or any combination of each)
		Electrical Kit (Recommend 20 amp)
1	Ea	Junction Box (4 ea. 20- amp twist lock outlet, GFI)
1	Ea	Wye Adapter
2	Ea	Adapter (Standard three blade plug to 20 amp twist lock plug)
2	Ea	Adapter (20 amp twist lock plug to standard three blade plug)
300	Feet	Extension Cord (at least 2-50', 12/3) (1-50', 10/3)
		Electrical Detection Device Kit
1	Ea	Non-contact electrical field detection and alert device
		First Aid Kit
1	Ea	Basic first aid supplies for minor injuries to six victims or crewmembers. Kit must include: Band aids, eye wash, 4"x 4" gauze pads, gauze dressings, triangular and elastic bandages, etc.
		Fuel Kit
1	Ea	Approved safety fuel can/s. The total gallons of gasoline required as a minimum stored in approved safety fuel cans to meet the Typing requirements. Type-3 , 1 – 2 ½" gallon container with gasoline and with pre-mix. Type-2 , 10 gallons fuel, only 2 fuel safety cans if the same ratio of pre-mix is used in both saws (chain & rotary). Type-1 , Could be 25 gallons if all listed tools were gasoline. If all the tools used the same pre-mix ratio, only 1 safety fuel can for the pre-mix and the minimum number of safety fuel cans to carry the balance of the minimum fuel required...
		Hydraulic Rescue Tool Kit

US&R TOOL INFO SHEET (TIS)		
QTY	UNIT	DESCRIPTION
1	Ea	Chain Set (rated for hydraulic spreader tool)
1	Ea	Cutter
2	Ea	Hose (minimum 20', if electric or gasoline power unit)
2	Qts	Hydraulic fluid
1	Ea	Power Unit (electric, gasoline or manual device)
2	Ea	Rams (adjustable length)
1	Ea	Spreader
		Gasoline
1	Ea	Fuel Kit (see tool info sheet) (only needed if gasoline powered)
1	Ea	Maintenance Kit (if gasoline, spark plug, air filter and wrench)
		Litter & Pre-Rig
1	Ea	Adjustable Pre-Rig (commercial or pre-assembled with 6 ea General use NFPA approved carabiners)
1	Ea	Rescue Litter Basket designed for horizontal and vertical lift, (litter shield optional)
		Load Releasing Device Kit
1	Ea	Commercial or field assembled device used to anchor and release tension from rope rescue systems, with General use NFPA approved carabiners.
		Lumber Kit
12	Ea	Lumber (4"x 4"x8')
4	Ea	Lumber (2"x 12"x 8') – (2" x 12" x 10' recommended)
4	Ea	Lumber (2" x 6" x 8') - (2" x 6" x 10' recommended) (2"x8"x8' or 2 ea. 2" x 12" x 8' can be used in place of)
4	Ea	Plywood (4'x 8'x ¾"x 5 ply)
		Mechanical Shoring Kit
6	Ea	Mechanical Shore (minimum SWL 7,200lbs. minimum span 6') (Any Combination of Ellis Post or Pipe Screw or Pneumatic with Associated Material and Equipment)
		Nail Gun Kit (Framing type – one or more of the following)
1	Ea	Nail Gun (6d –16d, pneumatic or gas actuated)
50	Lbs.	Nails, 16d (full head type, per nail gun manufacturer's specifications)
50	Lbs.	Nails, 8d (full head type, per nail gun manufacturer's specifications)
		Pneumatic
1	Ea	Air Hose (15')
1	Ea	Regulator
		Gas Actuated

US&R TOOL INFO SHEET (TIS)		
QTY	UNIT	DESCRIPTION
1	Ea	Battery Charger
2	Ea	Gas Cartridges
2	Ea	Spare Batteries
		Nail Gun Kit (Powder Actuated)
150	Ea	Boosters (per manufacturer's specifications)
1	Ea	Cleaning Kit
50	Ea	Fasteners (2-1/2" (63.5mm) pins with washers
50	Ea	Fasteners (2-7/8" (72mm) pins with washers
1	Ea	Nail Gun
		Nail Kit (Framing)
25	Lbs.	Nails, 16d
25	Lbs.	Nails, 8d
		Personal Protective Equipment Kit
1	Pr	Elbow Pads
1	Ea	Eye Protection
1	Ea	Gloves (leather)
1	Ea	Hearing Protection
1	Ea	Helmet
1	Ea	Helmet Light (intrinsically safe
1	Pr	Knee Pads
1	Ea	Respiratory Protection (per agency specifications, N95 minimum)
1	Ea	Safety Boots (safety toe)
1	Ea	Shirt & Pants (long sleeve)
1	Ea	Whistle
		PPE Victim Kit
1	Ea	Eye Protection
1	Ea	Harness
1	Ea	Helmet
		Personal Protective Equipment Kit (WMD)
1	Pr	Butyl Glove
1	Ea	Filter Cartridge, NBC (mil spec)
1	Ea	Full Face Respirator (must be able to accept NBC certified filter cartridges, SCBA mask can be used if it will accept NBC cartridges)
1	Pr	Haz-Mat Boot (NFPA approved)
1	Ea	Level B Suit (non-encapsulated, with attached booties & hood)
3	Ea	Mark 1 Kit DUODOTE (Atropine & 2-Pam Cl, auto eject pen)
1	Ea	Radiological Monitoring Device
		Note: This equipment is to be used for defensive

US&R TOOL INFO SHEET (TIS)		
QTY	UNIT	DESCRIPTION
		<i>operations only</i>
		Portable Radio Kit
2	Ea	Batteries (clam shell or rechargeable)
1	Ea	Battery Charger (if applicable)
1	Ea	Hand Held Radio (per agencies specifications)
		Rebar Cutter (One or more of the following)
1	Ea	Rebar Cutter, ($\frac{3}{4}$ ")
1	Ea	Spare Cutter Blades
		Cordless
1	Ea	Charger
2	Ea	Spare Batteries
		Reciprocating Saw Kit (Cordless)
1	Ea	Charger
1	Ea	Lubrication Oil
18	Ea	Metal Blades
1	Ea	Reciprocating Saw (variable speed)
2	Ea	Spare Batteries
12	Ea	Wood Blades
		Reciprocating Saw Kit (Electric)
1	Ea	Lubrication Oil
18	Ea	Metal Blades
1	Ea	Reciprocating Saw (variable speed)
12	Ea	Wood Blades
		Rotary Hammer Kit
4	Ea	Carbide Tip Masonry Bits ($\frac{1}{2}$ ")
1	Ea	Carbide Tip Masonry Bits (1"), Optional
2	Ea	Carbide Tip Masonry Bits ($\frac{3}{4}$ "), Optional
2	Ea	Chisel bits
1	Ea	Rotary Hammer ($1\frac{1}{2}$ " , electric, appropriate adapters for bits and depth range capability)
		Rotary Saw Kit
1	Ea	Fuel Kit, (<i>see tool info sheet</i>)
1	Ea	Maintenance Kit (spark plug, air filter belts and wrench)
2	Ea	Masonry Cutting Diamond Blade ($\frac{14}{16}$ "), wet or dry type)
12	Ea	Metal Cutting Abrasive Blade ($\frac{14}{16}$ "), or
2	Ea	Metal Cutting Multi-Purpose Blade ($\frac{14}{16}$ ")
1	Ea	Rotary Saw ($\frac{14}{16}$ ")

US&R TOOL INFO SHEET (TIS)		
QTY	UNIT	DESCRIPTION
2	Ea	Wood Cutting Carbide Blade (14"/16")
		Supplied Air Breathing Apparatus Kit (SABA or SAR)
4	Ea	Air Hose sets (minimum 300' / total 1200')
1	Ea	Air Source (air cart, air box, air manifold, etc.)
4	Ea	Escape Cylinders (10 min, with umbilical fittings and face piece)
		Tool Kit (Does not include any other tools required for maintenance and repair of equipment.)
1	Ea	Adjustable Wrench (12")
1	Ea	Adjustable Wrench (8")
1	Ea	Ball Peen Hammer
1	Ea	Breaker Bar (1/2")
1	Ea	Diagonal Wire Cutters
1	Ea	Locking Pliers (adjustable)
1	Ea	Metric Socket Set (1/2", ratchet and 6" extension)
1	Ea	Phillips Head Screwdriver Set
1	Ea	Slip Joint Pliers
1	Ea	Standard Head Screwdriver Set
1	Ea	Standard Socket Set (1/2", ratchet and 6" extension)
1	Ea	Tin Snips
1	Ea	Utility Knife
		Trauma Kit
1	Ea	Basic supplies to treat trauma injuries to six victims or crewmembers. Advanced Life Support equipment is not listed but may be carried if authorized. Medical equipment carried will depend on the responding agencies protocols. Examples: Large trauma dressings, splints, airways, BVM with assorted masks.
		Tri Pod Kit
1	Ea	Commercial Artificial High Anchor Point rated for rescue operations
1	Ea	Mechanical advantage retrieval system
		Ventilation System Kit
1	Ea	Confined Space Ventilation Fan (Electric)
1	Ea	Ducting, 15' minimum
		Visual Search Device Kit
1	Ea	Appropriately sized masonry bit and tool for search device
12	Ea	Chemical Light (White)

US&R TOOL INFO SHEET (TIS)		
QTY	UNIT	DESCRIPTION
1	Ea	Optical instrument with articulating viewing capability, such as a video search camera, fiber optic scope, etc.
		Webbing Kit (Webbing must be Nylon, 4000 lb. minimum tensile strength)
6	Ea	Webbing (1"x 5', green in color)
6	Ea	Webbing (1"x 12', yellow in color)
6	Ea	Webbing (1"x 15', blue in color)
6	Ea	Webbing (1"x 20', orange in color)

APPENDIX-E

REGIONAL US&R TASK FORCE

The Regional US&R Task Force Level is comprised of 29 people specially trained and equipped for large or complex US&R operations. The multi-disciplinary organization provides five functional elements that include Supervision, Search, Rescue, Medical, and Tool/Equipment Support. The Regional US&R Task Force is totally self-sufficient for the first 24 hours and organized for 12 hour operational periods. Transportation is provided by the sponsoring agency and logistical support will normally be provided by the requesting agency. RTFs are to be requested through the standard California Master Mutual Aid System.

The Regional US&R Task Force is supervised by a Task Force Leader. An Assistant Safety Officer – US&R is attached to the Task Force and will be incorporated into the existing incident's Safety Officer. The Assistant Safety Officer – US&R will work directly with the Taskforce Leader and should be assigned to the Taskforce's area of operation. The US&R Task Force Search element includes Canine and Technical Search capabilities. The Task Force Rescue element includes a Type 1 US&R Company (personnel and equipment), a Type 1 US&R Crew (personnel), and a Heavy Equipment and Rigging Specialist. This element can conduct rescue operations in all types of structures. The Task Force Medical element is responsible for the care and treatment of injured task force members or victims if such care must occur in the hazard area. The Medical element will work within the Incident Medical Unit or directly assigned to the Regional Taskforce as appropriate. The Tools and Equipment support element works within the Taskforce for tool and equipment repair and maintenance, and will coordinate with the Incident Logistics Section for acquisition of tools and equipment from off-incident locations.

REGIONAL US&R TASK FORCE ORGANIZATION CHART

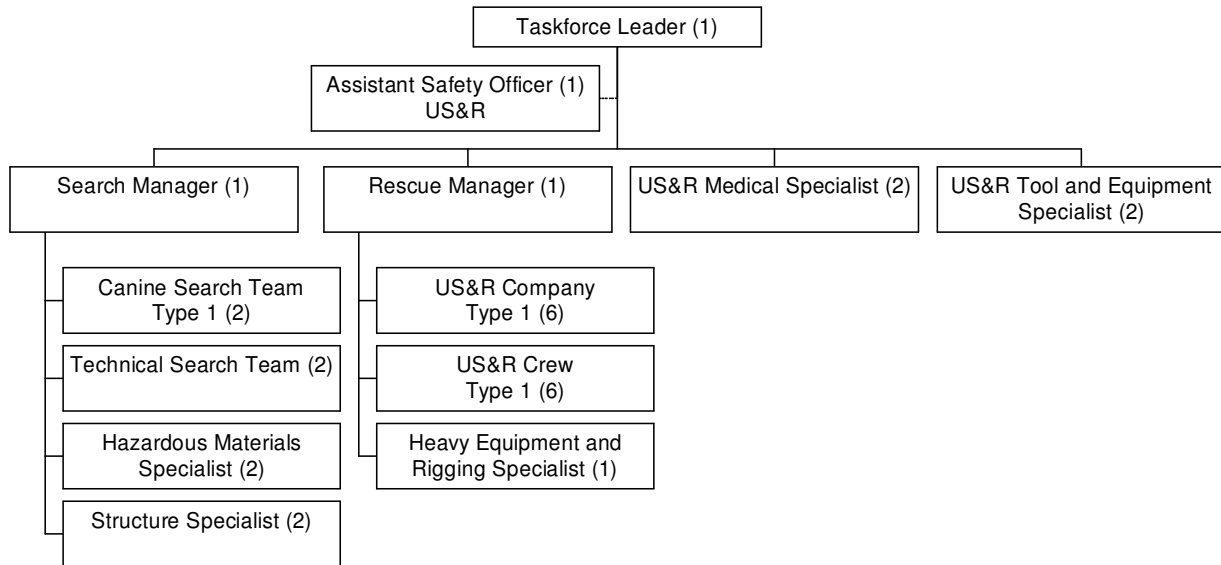

29 POSITIONS
12-HOUR OPERATIONAL CAPABILITY

APPENDIX-F

STATE/NATIONAL US&R TASK FORCE

The Federal Government, through the Federal Emergency Management Agency (FEMA), under the Department of Homeland Security (DHS), has established several State/National Urban Search & Rescue (US&R) Task Forces throughout the nation. All US&R Task Force activities are coordinated through the State Office of Emergency Services (OES) who serves as the primary point of contact for FEMA/DHS. A US&R Task Force is also a state resource that can be acquired without a request for Federal assistance. All requests for a US&R Task Force must go through normal Mutual Aid request procedures. A full, 70-person, Type I, National US&R Task Force is able to deploy within six hours of activation.

Each State/National US&R Task Force is comprised of 70 persons specifically trained and equipped for large or complex urban search and rescue operations. The multi-disciplinary organization provides seven functional elements that include Supervision, Search, Rescue, Haz Mat, Medical, Logistics and Planning. The State/National US&R Task Force can provide round-the-clock urban search and rescue operations (two 12-hour shifts). The US&R Task Force is totally self-sufficient for the first 72 hours and has a full equipment cache to support its operation. Either State or Federal resources provide transportation and logistical support.

A Task Force Leader supervises the State/National US&R Task Force. The US&R Task Force Search element includes physical, canine and electronic capabilities. The Rescue element can conduct rescue operations in all types of structures. The Haz Mat element is primarily responsible for the detection and decontamination of Chemical, Biological, Radiological, and Nuclear and Explosive (CBRNE) substances for Task Force members and entrapped victims. The Medical element is primarily responsible for the care and treatment of Task Force members and entrapped victims during extrication. The Logistics element provides the Task Force with logistical support and communications. The Planning element provides personnel competent in structural integrity assessments and documentation of Task Force activities.

The State/National US&R Task Force is designed to be used as a Single Resource, but is modularized into functional elements which can be independently requested and utilized. However, once mobilized as a State/National US&R Task Force, the elements shall remain under the supervision of the US&R Task Force Leader.

A Federal US&R Incident Support Team (IST) coordinates the arrival of a National US&R Task Force. The IST is capable of providing overhead management and logistical support to the US&R Task Force while on deployment if the appropriate ICS organization is not in place. If an ICS organization is in place, the IST will integrate into that structure. State/National US&R Task Forces will work within the local incident command structure.

STATE / NATIONAL US&R TASK FORCE ORGANIZATION CHART

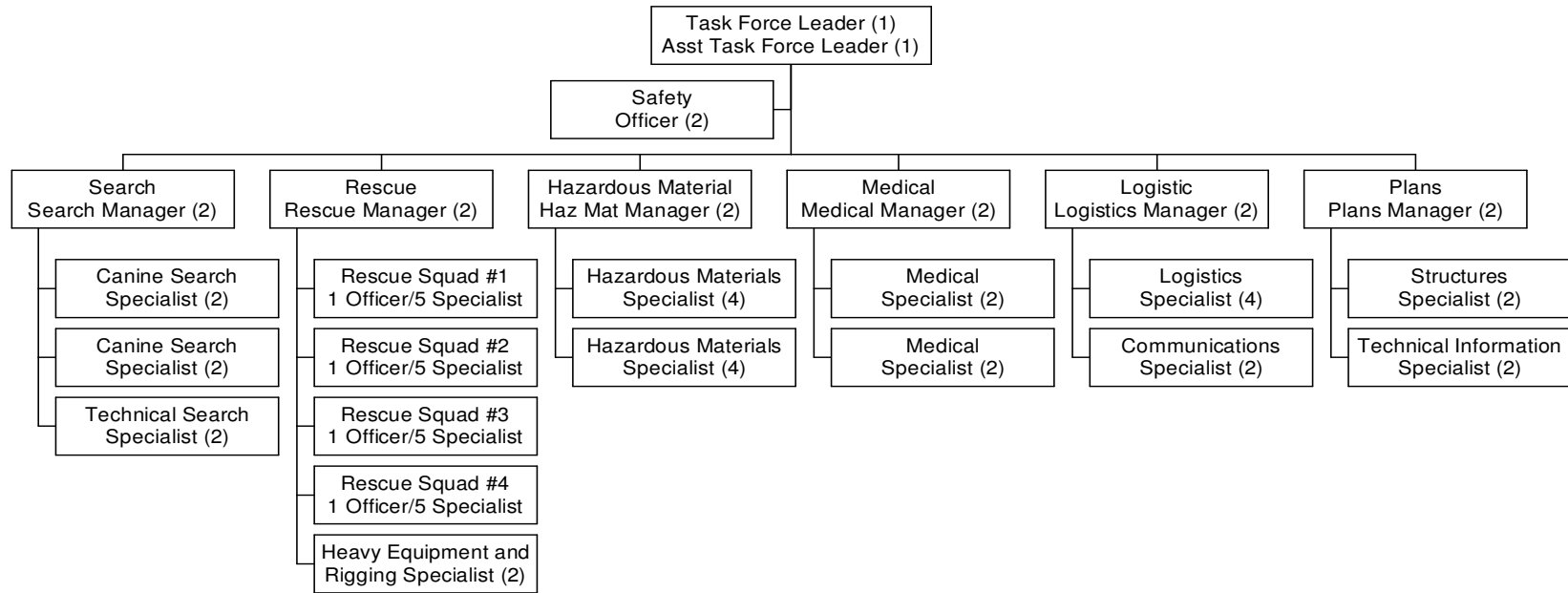

**70 POSITIONS
24-HOUR OPERATIONAL CAPABILITY
SELF SUFFICIENT FOR 72-HOURS**

APPENDIX-G

STRUCTURE/HAZARDS MARKING SYSTEM

At incidents involving several structures or large areas of damage, the identity and location of individual structures is crucial. The use of existing street names and addresses should always be considered first. If due to damage this is not possible, use the existing hundred block and place all even numbers on one side of the street and all odd numbers on the other side. Mark the new numbers on the front of the structure with orange spray paint. If due to damage the name of the street is not identifiable start with the letter "A" using the phonetic alphabet "Alpha", "Bravo", Charlie, etc.

Structure hazards identified during initial size up activities and throughout the incident should be noted. This Structure/Hazards Mark should be made on the outside of all normal entry points. Orange spray paint seems to be the most easily seen color on most backgrounds and line marking or downward spray cans apply the best paint marks. Lumber chalk or lumber crayons should be used to mark additional information inside the search mark itself because they are easier to write with than spray paint.

A large square box (approximately two feet) is outlined at any entrance accessible for entry into any compromised structure. Use orange paint for this marking. Specific markings will be clearly made adjacent to the box to indicate the condition of the structure and any hazards found at the time of this assessment. Normally the square box marking would be made immediately adjacent to the entry point identified as safe. An arrow will be placed next to the box indicating the direction of the safe entrance if the Structure/Hazards marking must be made somewhat remote from the safe entrance.

STRUCTURE/HAZARDS MARKINGS

Make a large (2' x2') square box with orange spray paint on the outside of the main entrance to the structure. Put the date, time, hazardous material conditions and team or company identifier outside the box on the right hand side. This information can be made with a lumber marking device.

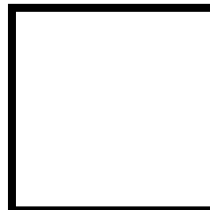

9/12/93
1310 hrs.
HM - nat.
gas
SMA - E-1

Structure is accessible and safe for search and rescue operations. Damage is minor with little danger of further collapse.

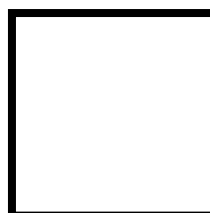

9/12/93
1310 hrs.
HM - none
SMA - E-1

Structure is significantly damaged. Some areas are relatively safe, but other areas may need shoring, bracing, or removal of falling and collapse hazards.

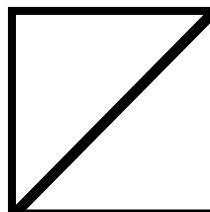

9/12/93
1310 hrs.
HM - nat. gas
SMA - E-1

Structure is not safe for search or rescue operations. May be subject to sudden additional collapse. Remote search ops may proceed at significant risk. If rescue ops are undertaken, safe haven areas and rapid evacuation routes should be created.

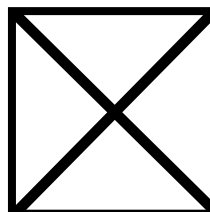

9/12/93
1310 hrs.
HM - nat. gas
SMA - E-1

Arrow located next to a marking box indicates the direction to a safe entrance into the structure, should the marking box need to be made remote from the indicated entrance.



APPENDIX-H

SEARCH MARKING SYSTEM

Search Markings must be easy to make, easy to read and easy to understand. To be easily seen the search mark must be large and of a contrasting color to the background surface. Orange spray paint seems to be the most easily seen color on most backgrounds and line marking or downward spray cans apply the best paint marks. A lumber marking device may be used to write additional information inside the search mark itself when it would be difficult to write the additional information with spray paint.

A large distinct marking will be made outside the main entrance of each building, structure or area to be searched. This "Main Entrance" search marking will be completed in two steps. First, a large single slash (approximately two feet) shall be made starting at the upper left moving to the lower right near the main entrance at the start of the search. The Search Team identifier and time that the structure was entered shall be marked to the left of the mid point of the slash and the date shall be marked near the top of the slash on the opposite side.

When the search of the entire structure is complete and the Search Team exits the building, a second large slash shall be made in the opposite direction forming an "X" on the Main Entrance search marking. Additional information summarizing the entire search of the structure will be placed in three quadrants of the "X". The left quadrant will already contain the Search Team identifier and time when the team first entered the structure. In the top quadrant enter the time the Search Team exited the structure under the date. Change the date if different from date the structure was entered. The right quadrant is for any significant hazards located inside the structure. The bottom quadrant is for the number of live "V" or dead "V" victims still inside the structure. Use a small "X" in the bottom quadrant if no victims are inside the structure.

If the search of the entire structure is incomplete, make a circle (approximately 1' diameter) in the middle of the single slash. The left side will already contain the Search Team identifier and time when the team first entered the structure. At the top end of the slash enter the time the Search Team exited the structure under the date. Change the date if different from date the structure was entered. On the right side, mid point of the slash, is for any significant hazards located inside the structure. The bottom end of the slash is for the number of live "V" or dead "V" victims still inside the structure. Use a small "X" at the bottom if no victims are inside the structure.

During the search function while inside the structure a large single slash shall be made upon entry of each room, area or floor. After the search of the room or area has been completed, a second large slash shall be drawn in the opposite direction forming an "X". The only additional information placed in any of the "X" quadrants while inside the structure shall be that pertaining to any significant hazards and the number of live "V" or dead "V" victims, as indicated by "V" for live and "V" for dead.

SEARCH MARKINGS

Main Entrance Search Marking- WHEN YOU ENTER

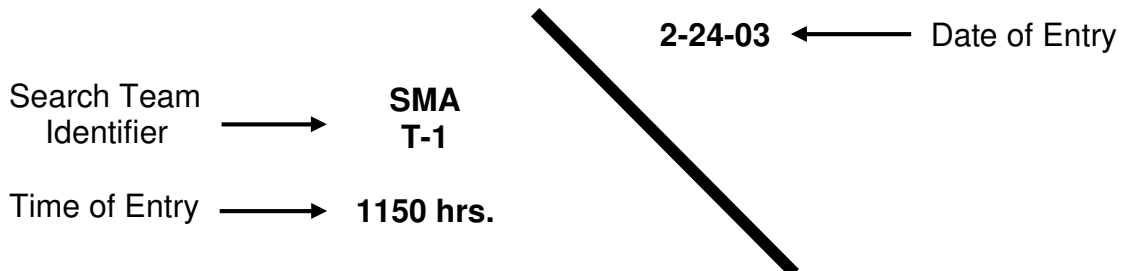

Main Entrance Search Marking- WHEN YOU EXIT

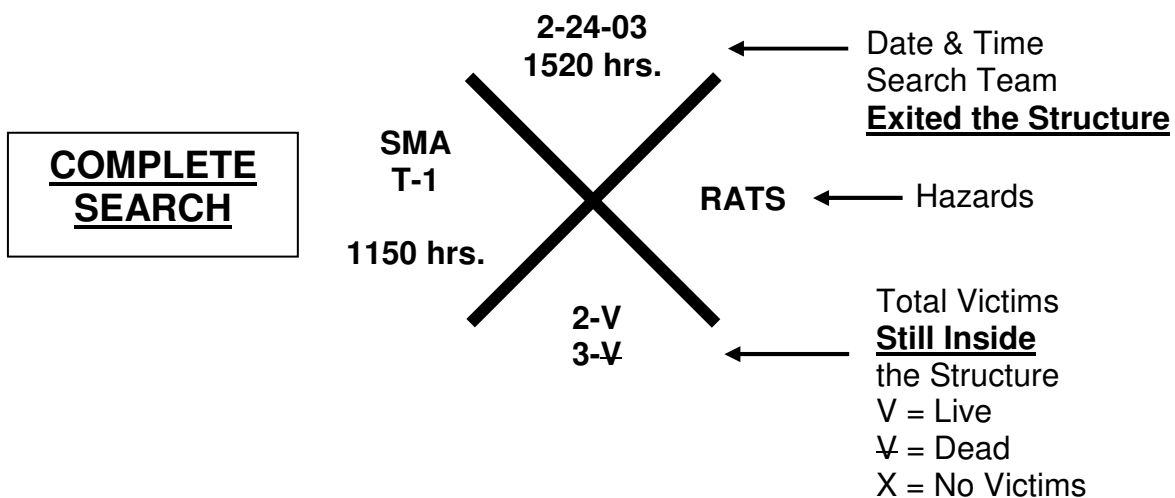

Main Entrance Search Marking- WHEN YOU EXIT

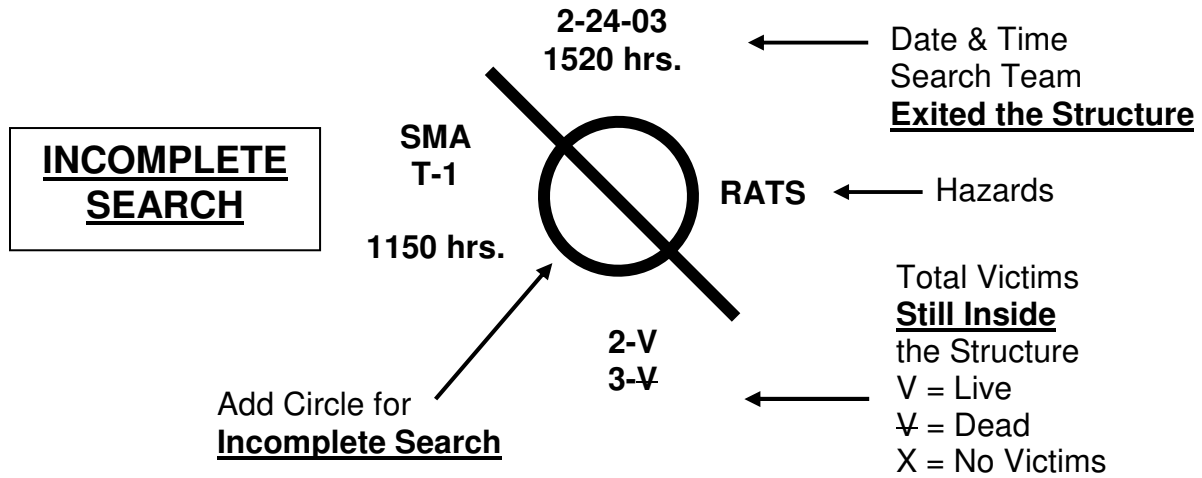

Interior Search Markings- EACH ROOM, AREA OR FLOOR

WHEN YOU ENTER

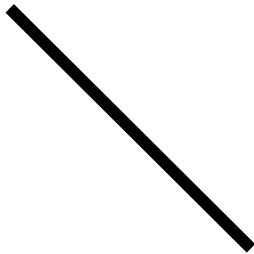

WHEN YOU EXIT

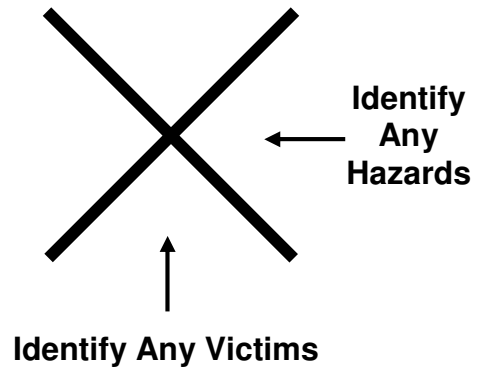

APPENDIX-I

VICTIM MARKING SYSTEM

Make a large (2' x 2') "V" with orange spray paint near the location of a **potential** victim. Mark the name of the search team or crew identifier in the top part of the "V" with paint or a lumber marker type device.

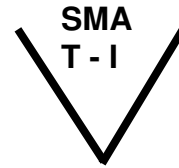

Paint a circle around the "V" when a potential victim is **confirmed** to be **alive** either visually, vocally, or hearing specific sounds that would indicate a high probability of a live victim. If more than one confirmed live victim, mark the total number of victims under the "V".

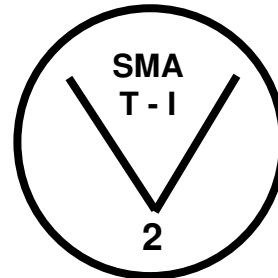

Paint a horizontal line through the middle of the "V" when a **confirmed** victim is determined to be **deceased**. If more than one confirmed deceased victim, mark the total number of victims under the "V". Use both the live and deceased victim marking symbols when a combination of live and deceased victims are determined to be in the same location.

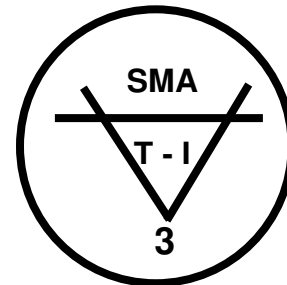

Paint an "X" through the confirmed victim symbol after **all** victim(s) have been removed from the specific location identified by the marking.

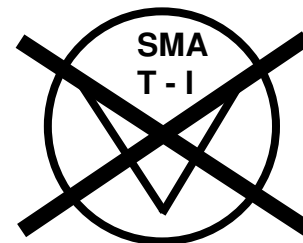

An arrow may need to be painted next to the "V" pointing towards the victim when the victim's location is not immediately near where the "V" is painted.

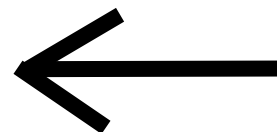

APPENDIX-J

EMERGENCY SIGNALING SYSTEM

Because of the high potential of secondary collapse, dangerous conditions, and the need to communicate other important information, an emergency signaling system should be adopted and in use by all personnel at the incident site. Emergency signals must be a loud and identifiable and sounded when conditions require immediate attention. Emergency signals can be made using devices such as a whistle, air horn, vehicle horn or bell. Each structure or larger area of operations may need to have its own distinct emergency signal device when multiple rescue operations are taking place in the same area to reduce confusion.

Supervisors should identify and inform assigned personnel of a designated place of assembly and/or safe zone for a Personal Accountability Report (PAR) to be conducted should an evacuation signal be sounded. A place of assembly is usually a safe location outside the evacuation area. A safe zone is usually a safe location within a building or disaster site that can be entered within the evacuation area. When an evacuation signal is sounded, all supervisors must conduct a roll call of their assigned personnel and communicate the results of the PAR to their supervisor.

Evacuate the area

Short signals repeated for 10 seconds, pause for 10 seconds, and repeat for 3 repetitions. Total signal time – 50 seconds.

Cease Operations / All quite

One long signal (8 to 10 seconds)

Resume Operations

One long and one short signal.

APPENDIX K

Chemical Light and Flagging Tape Plan

Chemical light marking for low light and night operation should include flagging tape of the same color as the light stick.

WHITE

MARKER-NEUTRAL

RED

NO GO, HAZARD

YELLOW

CAUTION

GREEN

ENTRY LOCATION,
PERSONNEL

PATH

BLUE

VICTIM

*Each lighted location should be accompanied by the appropriate building, search or victim marking as referenced on pages xx thru xx as necessary.